

Heat pumps

ecoGEO⁺

ecoGEO⁺ & AU

ecoAIR⁺



Ecoforest heat pumps

Technology for a sustainable world

Ecoforest is committed to innovation in order to achieve a sustainable future based on the use of renewable energy. This commitment has led Ecoforest to become a technological leader in the field of Inverter heat pumps, being the only manufacturer whose product range presents such modulating technology in all its models, both geothermal and aérothermal.



Ecoforest heat pumps allow to cover in an integrated way all the thermal needs of current buildings, as well domestic as industrial. Ecoforest offers three types of solutions depending on the energy source used by the equipment: ecoGEO⁺ water-to-water geothermal heat pumps, ecoGEO⁺ & AU water-to-water aérothermal heat pumps, and ecoAIR⁺ aérothermal air-water monobloc heat pumps. All the models in these three ranges make use of Inverter technology to obtain the best performances and thus guarantee comfort and efficiency together with a commitment to make the best use of renewable resources.

INDEX

ecoGEO⁺	4
ecoGEO⁺ Basic & Compact	6
ecoGEO ⁺ 1-6 PRO	8
ecoGEO ⁺ 1-9	10
ecoGEO ⁺ 3-12	12
ecoGEO ⁺ 5-22	14
ecoGEO⁺ HP	16
ecoGEO ⁺ 12-40	18
ecoGEO ⁺ 15-70	20
ecoGEO ⁺ 25-100	22
ecoGEO⁺ & AU	24
ecoGEO⁺ Basic/Compact & AU	26
Outdoor aérothermal units AU6 / AU12 / AU22	28
ecoGEO ⁺ 1-6 PRO & AU6	30
ecoGEO ⁺ 1-9 & AU12	32
ecoGEO ⁺ 3-12 & AU12	34
ecoGEO ⁺ 5-22 & AU12	36
ecoGEO ⁺ 5-22 & AU22	38
ecoAIR⁺	40
ecoAIR⁺ PRO	42
Indoor units CM / HK / HK-Compact	44
ecoAIR ⁺ 1-7 PRO	46
ecoAIR ⁺ 1-9 PRO	48
ecoAIR ⁺ 3-12 PRO	50
ecoAIR ⁺ 3-18 PRO	52
ecoAIR⁺ EVI	54
Indoor units CM / HK / HK-Compact	56
ecoAIR ⁺ EVI 4-20	58

ecoGEO⁺

Ground source heat pumps



ecoGEO⁺

Inverter ground source, the most efficient technology

The ecoGEO⁺ range is the Ecoforest range of geothermal heat pumps. These heat pumps, both domestic and high power, are compatible with any of the type of ground source collection system, even with hybrid aerothermal-geothermal collection systems and fully aerothermal collection systems. Likewise, they are also capable of offering all the services required in a HVAC system in an integrated way: DHW, Heating, Pool, Passive Cooling (or Free Cooling) and Active Cooling.



All ecoGEO⁺ heat pumps make use of Inverter technology, which allows them to modulate their power in order to adapt to the thermal demands of the installation with the highest efficiency. This translates into a very considerable reduction in electrical consumption and great savings. Thanks to the technology and control strategies developed by Ecoforest, the installation of ecoGEO⁺ heat pumps also becomes much simpler, more compact and cheaper than those of other heat pumps on the market, since it allows to dispense with certain components that would be necessary in traditional heat pump installations.

ecoGEO+ Basic & Compact

Residential range



Power ranges

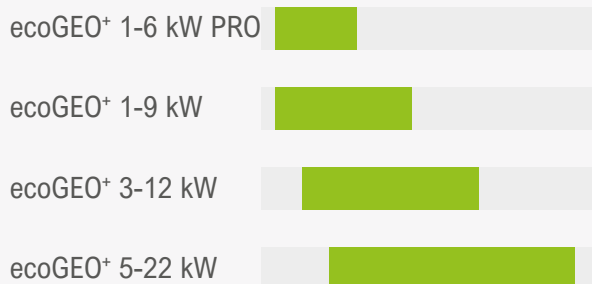

Cascade

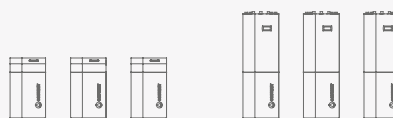

Services



DHW



Heating



Cooling



Pool

Models

ecoGEO+ B1/C1

DHW
Heating
Pool

ecoGEO+ B2/C2

DHW
Heating
Pool
Free Cooling

ecoGEO+ B3/C3

DHW
Heating
Pool
Active Cooling

ecoGEO+ B4/C4

DHW
Heating
Pool
Free Cooling
Active Cooling



Inverter technology

Power ranges: 1-6 kW / 1-9 kW / 3-12 kW / 5-22 kW

Domestic hot water production

Heating and pool production

Integrated active cooling production

Integrated passive (free) cooling production

Internet connection through the ecoSMART Easynet

Integrated photovoltaic hybridisation

HTR technology for DHW production up to 70°C and simultaneous production of several services

Natural refrigerant used in ecoGEO+ PRO models allowing DHW production temperature up to 75°C

Integrated cascade management up to 3 units

Single-phase (230V) or three-phase (400V) power supply

Collection system



Ground



Open loop



Air



Hybrid



ecoGEO+ B/C 1-6 PRO



- Modulating thermal power control within a wide range (15-100%) and modulating flow rate control of both brine and production circuits (20-100%).
- Natural refrigerant R290 : GWP 3.
- Inverter technology.
- Compact design including brine and production circulation pumps, brine and production expansion vessels (8l and 12l respectively), brine and production safety valves and DHW three-way valve.
- Integrated management of up to 3 different emission temperatures, 2 buffer tanks (heating and cooling), 1 DHW tank, 1 pool and hourly control of DHW recirculation.
- Integrated management of aérothermal collection modulating units, in case of air source or hybrid configurations.
- Integrated management of external On/Off or modulating auxiliary systems, such as electrical heaters, On/Off boilers or modulating boilers.
- Integrated free cooling in models 2 and 4.
- Integrated active cooling in models 3 and 4.
- Single-phase version available.
- Integrated photovoltaic hybridisation.
- Integrated energy meters to measure the electrical consumption, the heating/cooling thermal power, the COP and the monthly and annual SPF.

SPECIFICATIONS ecoGEO+ B/C 1-6 PRO		UNITS	B1/C1	B2/C2	B3/C3	B4/C4	
APPLICATION	Place of installation	-	Indoors				
	Type of brine system ¹	-	Ground source / Air source / Hybrid source				
	DHW, Heating and Pool	-	✓	✓	✓	✓	
	High Temperature Recovery (HTR) system option	-	-	-	-	-	
	Integrated Active cooling	-	-	-	✓	✓	
PERFORMANCE	Integrated Passive cooling	-	-	✓	-	✓	
	Modulation range of the compressor	%	15 to 100				
	Heating power output ^{2, 10} , B0W35	kW	1,0 to 6,0				
	COP ^{2, 10} , B0W35	-	4,3				
	Active cooling power output ^{2, 10} , B35W7	kW	-	1,0 to 6,0			
	EER ^{2, 10} , B35W7	-	-	4,5			
	Max. DHW temperature without / with support ⁵	°C	75 / 80				
	Noise power emission level ^{6, 10}	db	33 to 44				
	Energy label / rjs / SCOP W35 average climate control	-	A+++ / 192% / 5,0				
	Energy label / rjs / SCOP W55 average climate control	-	A++ / 142% / 3,74				
OPERATION LIMITS	Distribution / Set heating outlet temperature range	°C	10 to 75 / 20 to 75				
	Distribution / Set cooling outlet temperature range	°C	4 to 35 / 7 to 25				
	Brine inlet temperature range in heating applications	°C	-25 to 35				
	Brine inlet temperature range in cooling applications	°C	10 to 75				
	Minimum / Maximum refrigerant circuit pressure	bar	0,7 / 31,5				
	Production / Pre-load circuit pressure	bar	0,5 to 3,0 / 1,5				
	Brine / Pre-load circuit pressure	bar	0,5 to 3,0 / 0,7				
WORKING FLUIDS	Volume / Max. DHW storage tank pressure (ecoGEO+ C)	l / bar	165 / 8				
	R290 Refrigerant load	kg	0,15				
	Compressor oil type / load	kg	PZ46M / 0,3				
CONTROL ELECTRICAL DATA	1/N/PE 230 V / 50-60 Hz ⁸	-	✓				
	Maximum recommended external protection ⁹	-	C10A				
	Transformer primary circuit fuse	A	0,5				
ELECTRICAL DATA: SINGLE-PHASE	Transformer secondary circuit fuse	A	2,5				
	1/N/PE 230 V / 50-60 Hz ⁸	-	✓				
	Maximum recommended external protection ⁹	-	C25A				
	Maximum consumption ² , B0W35	kW / A	1,6 / 6,8				
	Maximum consumption ² , B0W55	kW / A	2,0 / 8,6				
DIMENSIONS/WEIGHT	Minimum / Maximum starting current ⁷	A	0,6 / 1,8				
	Correction of cosine Ø	-	0,96/1				
	Height x width x depth	mm	ecoGEO+ B: 1060x550x602 · ecoGEO+ C: 1804x600x720				
	Empty weight (without assembly)	kg	B 125 · C 186	B 133 · C 194	B 125 · C 186	B 133 · C 194	

- Air source by replacing the ground source circuit by one or more ecoGEO+ AU air units. Consult the ecoGEO+ AU aérothermal units manual for more detailed information.
- In compliance with EN 14511, this includes the consumption of the circulation pumps and the compressor driver.
- Considering brine and production flow rates in compliance with EN 14511.
- Considering a heat slope from 20°C to 50°C in absence of consumption.
- Considering support provided by the emergency electrical heater.
- In compliance with EN 12102, this includes the acoustic insulation kit of the compressor.
- Starting current depends on the working conditions of the hydraulic circuits.
- The admissible voltage range for proper operation of the heat pump is ±10%.
- Maximum consumption can vary significantly according to working conditions, or if the compressor's operation range is restricted. Consult the technical service manual for more detailed information.
- Certification in process.

Dimensions and hydraulic connections

Operational chart

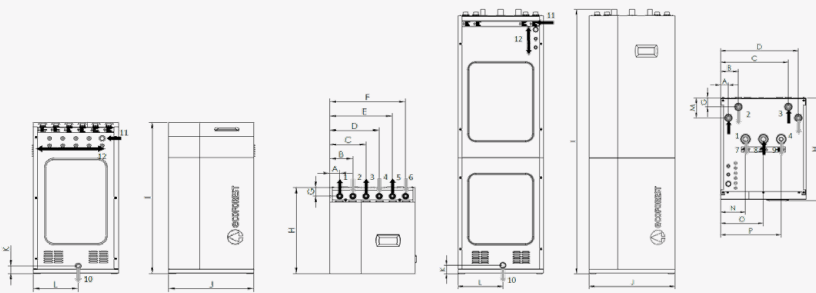

MODEL	DIMENSIONS (mm)															
	A	B	C	D	E	F	G	H	I	J	K	L	M	N	O	P
ecoGEO+ Basic	63	148	233	318	403	488	60	602	1058	550	53	290	-	-	-	-
ecoGEO+ Compact	55	125	475	545	-	-	62	720	1851	600	58	315	140	175	300	425

1. Heating/Cooling Outlet - 1" M
2. Heating/Cooling Inlet - 1" M
3. Brine Outlet - 1" M
4. Brine Inlet - 1" M
5. DHW System Outlet - 1" M
6. DHW System Inlet - 1" M
7. DCW Inlet - 1" F
8. DHW Outlet - 1" F
9. DHW Recirculation Inlet - 3/4" F
10. Drain - 16 mm

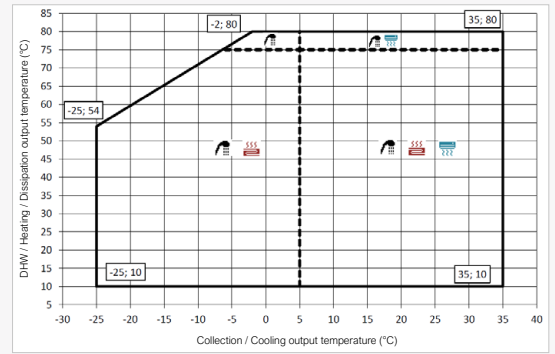

Installation management

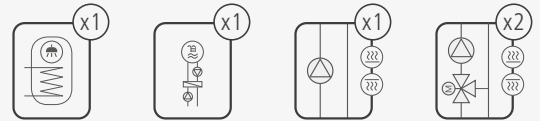

Performance curves

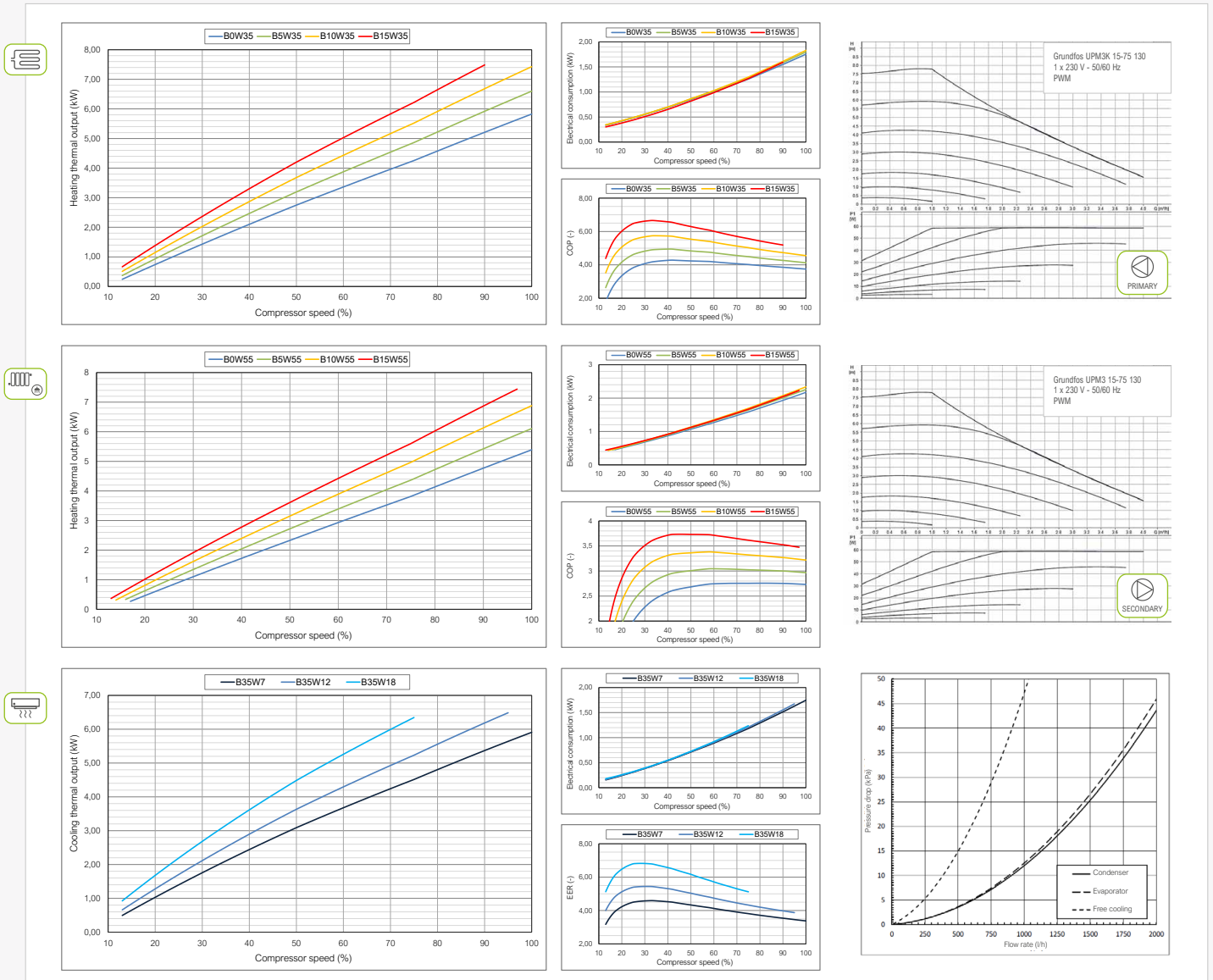

ecoGEO+ B/C 1-9

- Modulating thermal power control within a wide range (20-100%) and modulating flow rate control of both brine and production circuits (20-100%).
- Inverter technology and scroll compressor.
- Compact design including brine and production circulation pumps, brine and production expansion vessels (8l and 12l respectively), brine and production safety valves and DHW three-way valve.
- High Temperature Recovery system (HTR) for DHW production up to 70 °C without electrical support and simultaneous production of DHW and heating/cooling.
- Integrated management of up to 4 different emission temperatures, 2 buffer tanks (heating and cooling), 1 DHW tank, 1 pool and hourly control of DHW recirculation.
- Integrated management of aerothermal collection modulating units, in case of air source or hybrid configurations.
- Integrated management of external On/Off or modulating auxiliary systems, such as electrical heaters, On/Off boilers or modulating boilers.
- Integrated management of cascade systems up to 3 units.
- Integrated management of simultaneous cooling/heating systems according to scheme.
- Integrated free cooling in models 2 and 4.
- Integrated active cooling in models 3 and 4.
- Single-phase and Three-phase versions available.
- Integrated photovoltaic hybridisation.
- Integrated energy meters to measure the electrical consumption, the heating/cooling thermal power, the COP and the monthly and annual SPF.

SPECIFICATIONS ecoGEO+ B/C 1-9		UNITS	B1/C1	B2/C2	B3/C3	B4/C4	
APPLICATION	Place of installation	-	Indoors				
	Type of brine system ¹	-	Ground source / Air source / Hybrid source				
	DHW, Heating and Pool	-	✓	✓	✓	✓	
	High Temperature Recovery (HTR) system option	-	✓	✓	✓ by default	✓ by default	
	Integrated Active cooling	-	-	-	✓	✓	
PERFORMANCE	Integrated Passive cooling	-	-	✓	-	✓	
	Modulation range of the compressor	%	20 to 100				
	Heating power output ² , B0W35	kW	1,3 to 11,0				
	COP ² , B0W35	-	4,5				
	Active cooling power output ² , B35W7	kW	-	1,4 to 11,0			
	EER ² , B35W7	-	-	5,2			
	Max. DHW temperature without / with support ⁵	°C	63 / 70				
	Noise power emission level ⁶	db	33 to 44				
	Energy label / rjs / SCOP W35 average climate control	-	A+++ / 186% / 4,85				
	Energy label / rjs / SCOP W55 average climate control	-	A++ / 138% / 3,65				
OPERATION LIMITS	Distribution / Set heating outlet temperature range	°C	10 to 60 / 20 to 60				
	Distribution / Set cooling outlet temperature range	°C	4 to 35 / 7 to 25				
	Brine inlet temperature range in heating applications	°C	-25 to 35				
	Brine inlet temperature range in cooling applications	°C	10 to 60				
	Minimum / Maximum refrigerant circuit pressure	bar	2 / 45				
	Production / Pre-load circuit pressure	bar	0,5 to 3,0 / 1,5				
	Brine / Pre-load circuit pressure	bar	0,5 to 3,0 / 0,7				
	Volume / Max. DHW storage tank pressure (ecoGEO+ C)	l / bar	165 / 8				
WORKING FLUIDS	R410A Refrigerant load without HTR / with HTR	kg	0,75 / 0,85		1,0		
	Compressor oil type / load	kg	POE / 0,74				
CONTROL ELECTRICAL DATA	1/N/PE 230 V / 50-60 Hz ⁸	-	✓				
	Maximum recommended external protection ⁹	-	C10A				
	Transformer primary circuit fuse	A	0,5				
	Transformer secondary circuit fuse	A	2,5				
ELECTRICAL DATA: SINGLE-PHASE	1/N/PE 230 V / 50-60 Hz ⁸	-	✓				
	Maximum recommended external protection ⁹	-	C25A				
	Maximum consumption ² , B0W35	kW / A	2,7 / 11,8				
	Maximum consumption ² , B0W55	kW / A	3,8 / 16,5				
	Minimum / Maximum starting current ⁷	A	2,8 / 5,8				
	Correction of cosine Ø	-	0,96/1				
ELECTRICAL DATA: THREE-PHASE	3/N/PE 400 V / 50-60Hz ⁸	-	✓				
	Maximum recommended external protection ⁹	-	C10A				
	Maximum consumption ² , B0W35	kW / A	2,7 / 4,0				
	Maximum consumption ² , B0W55	kW / A	3,8 / 5,5				
	Minimum / Maximum starting current ⁷	A	0,9 / 1,9				
	Correction of cosine Ø	-	0,96/1				
DIMENSIONS/WEIGHT	Height x width x depth	mm	ecoGEO+ B: 1060x600x710 · ecoGEO+ C: 1804x600x720				
	Empty weight (without assembly)	kg	B 184 · C 245	B 192 · C 253	B 184 · C 245	B 192 · C 253	

- Air source/Hybrid source by replacing/combining the ground source circuit by/with one or more ecoGEO+ AU. Consult the ecoGEO+ AU manual for more detailed information.
- In compliance with EN 14511, this includes the consumption of the circulation pumps and the compressor driver.
- Considering brine and production flow rates in compliance with EN 14511.
- Considering a heat slope from 20°C to 50°C in absence of consumption.
- Considering support provided by the emergency electrical heater or the HTR system. Maximum DHW temperature with the HTR system can be limited by the compressor discharge temperature.
- In compliance with EN 12102, this includes the acoustic insulation kit of the compressor.
- Starting current depends on the working conditions of the hydraulic circuits.
- The admissible voltage range for proper operation of the heat pump is ±10%.
- Maximum consumption can vary significantly according to working conditions, or if the compressor's operation range is restricted. Consult the technical service manual for more detailed information.
- Certification in process.

Dimensions and hydraulic connections

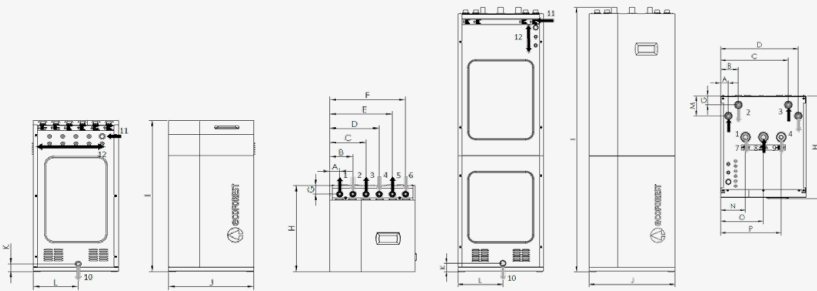

MODEL	DIMENSIONS (mm)															
	A	B	C	D	E	F	G	H	I	J	K	L	M	N	O	P
ecoGEO+ Basic	55	153	251	349	447	545	70	710	1058	600	61	300	-	-	-	-
ecoGEO+ Compact	55	125	475	545	-	-	62	720	1851	600	58	315	140	175	300	425

1. Heating/Cooling Outlet - 1 1/4" M
2. Heating/Cooling Inlet - 1 1/4" M
3. Brine Outlet - 1 1/4" M
4. Brine Inlet - 1 1/4" M
5. DHW System Outlet - 1 1/4" M
6. DHW System Inlet - 1 1/4" M
7. DCW Inlet - 1" F
8. DHW Outlet - 1" F
9. DHW Recirculation Inlet - 3/4" F
10. Drain - 16 mm

Operational chart

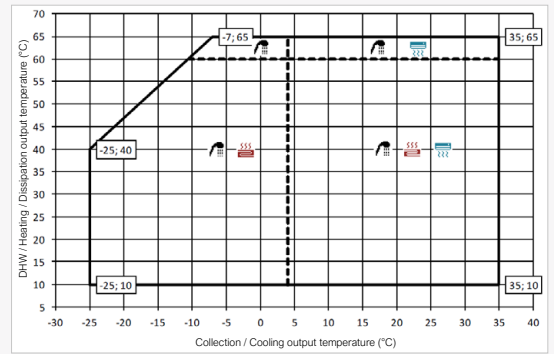

Installation management

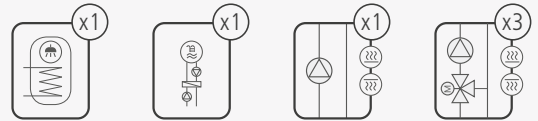

Performance curves

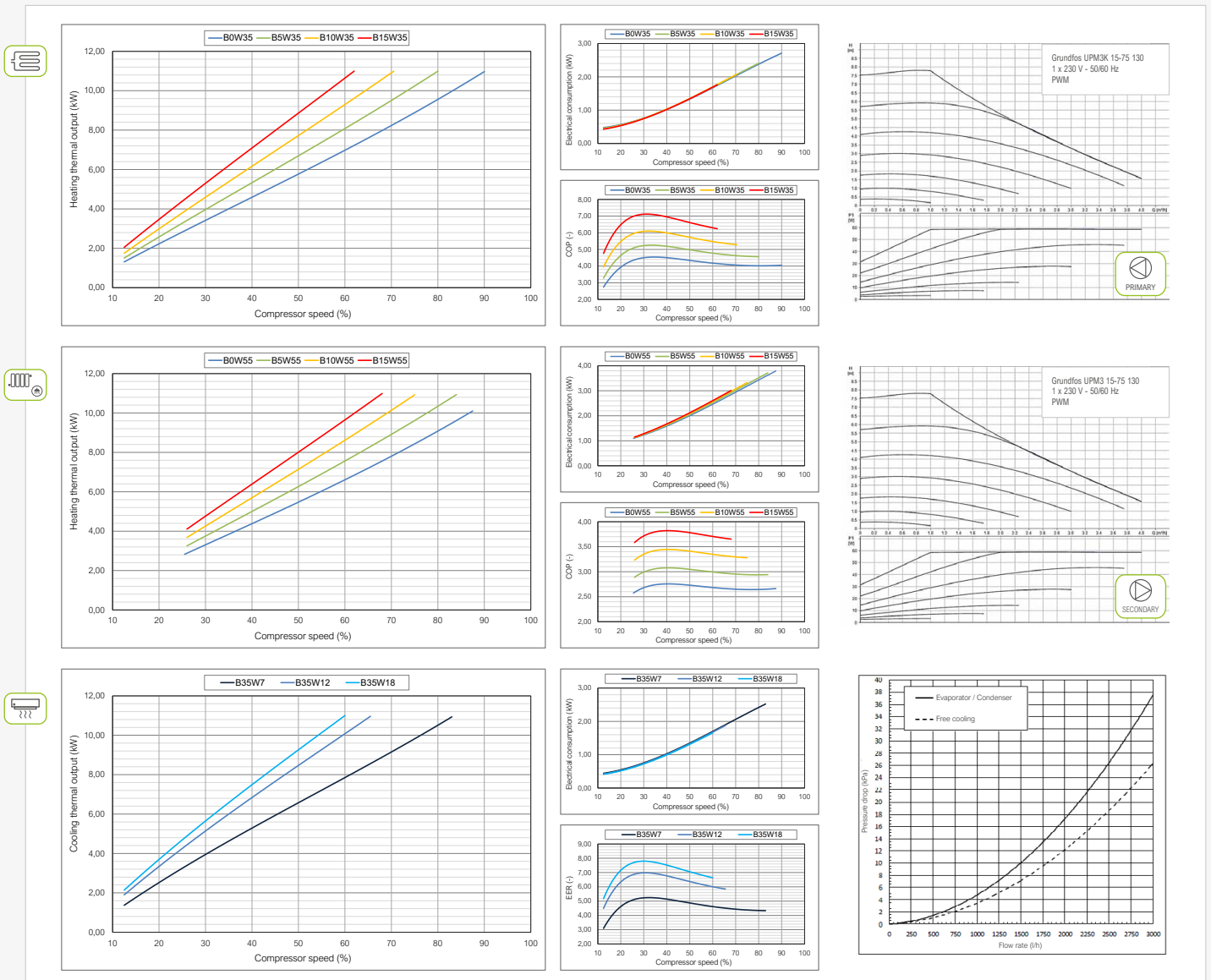

ecoGEO+ B/C 3-12

- Modulating thermal power control within a wide range (20-100%) and modulating flow rate control of both brine and production circuits (20-100%).
- Inverter technology and scroll compressor.
- Compact design including brine and production circulation pumps, brine and production expansion vessels (8l and 12l respectively), brine and production safety valves and DHW three-way valve.
- High Temperature Recovery system (HTR) for DHW production up to 70 °C without electrical support and simultaneous production of DHW and heating/cooling.
- Integrated management of up to 4 different emission temperatures, 2 buffer tanks (heating and cooling), 1 DHW tank, 1 pool and hourly control of DHW recirculation.
- Integrated management of aerothermal collection modulating units, in case of air source or hybrid configurations.
- Integrated management of external On/Off or modulating auxiliary systems, such as electrical heaters, On/Off boilers or modulating boilers.
- Integrated management of cascade systems up to 3 units.
- Integrated management of simultaneous cooling/heating systems according to scheme.
- Integrated free cooling in models 2 and 4.
- Integrated active cooling in models 3 and 4.
- Single-phase and Three-phase versions available.
- Integrated photovoltaic hybridisation.
- Integrated energy meters to measure the electrical consumption, the heating/cooling thermal power, the COP and the monthly and annual SPF.

SPECIFICATIONS ecoGEO+ B/C 3-12		UNITS	B1/C1	B2/C2	B3/C3	B4/C4	
APPLICATION	Place of installation	-	Indoors				
	Type of brine system ¹	-	Ground source / Air source / Hybrid source				
	DHW, Heating and Pool	-	✓	✓	✓	✓	
	High Temperature Recovery (HTR) system option	-	✓	✓	✓ by default	✓ by default	
	Integrated Active cooling	-	-	-	✓	✓	
PERFORMANCE	Integrated Passive cooling	-	-	✓	-	✓	
	Modulation range of the compressor	%	20 to 100				
	Heating power output ² , B0W35	kW	2,5 to 16,0				
	COP ² , B0W35	-	4,6				
	Active cooling power output ² , B35W7	kW	-	3,1 to 15,0			
	EER ² , B35W7	-	-	5,2			
	Max. DHW temperature without / with support ⁵	°C	63 / 70				
	Noise power emission level ⁶	db	34 to 45				
	Energy label / rjs / SCOP W35 average climate control	-	A+++ / 194% / 5,05				
	Energy label / rjs / SCOP W55 average climate control	-	A++ / 142% / 3,75				
OPERATION LIMITS	Distribution / Set heating outlet temperature range	°C	10 to 60 / 20 to 60				
	Distribution / Set cooling outlet temperature range	°C	4 to 35 / 7 to 25				
	Brine inlet temperature range in heating applications	°C	-25 to 35				
	Brine inlet temperature range in cooling applications	°C	10 to 60				
	Minimum / Maximum refrigerant circuit pressure	bar	2 / 45				
	Production / Pre-load circuit pressure	bar	0,5 to 3,0 / 1,5				
	Brine / Pre-load circuit pressure	bar	0,5 to 3,0 / 0,7				
	Volume / Max. DHW storage tank pressure (ecoGEO+ C)	l / bar	165 / 8				
WORKING FLUIDS	R410A Refrigerant load without HTR / with HTR	kg	0,9 / 1,0		1,0		
	Compressor oil type / load	kg	POE / 0,74				
CONTROL ELECTRICAL DATA	1/N/PE 230 V / 50-60 Hz ⁸	-	✓				
	Maximum recommended external protection ⁹	-	C16A				
	Transformer primary circuit fuse	A	0,5				
	Transformer secondary circuit fuse	A	2,5				
ELECTRICAL DATA: SINGLE-PHASE	1/N/PE 230 V / 50-60 Hz ⁸	-	✓				
	Maximum recommended external protection ⁹	-	C32A				
	Maximum consumption ² , B0W35	kW / A	4,2 / 18,6				
	Maximum consumption ² , B0W55	kW / A	5,0 / 21,7				
	Minimum / Maximum starting current ⁷	A	2,0 / 8,0				
	Correction of cosine Ø	-	0,96/1				
ELECTRICAL DATA: THREE-PHASE	3/N/PE 400 V / 50-60Hz ⁸	-	✓				
	Maximum recommended external protection ⁹	-	C16A				
	Maximum consumption ² , B0W35	kW / A	4,2 / 6,2				
	Maximum consumption ² , B0W55	kW / A	5,0 / 7,2				
	Minimum / Maximum starting current ⁷	A	0,7 / 2,6				
	Correction of cosine Ø	-	0,96/1				
DIMENSIONS/WEIGHT	Height x width x depth	mm	ecoGEO+ B: 1060x600x710 · ecoGEO+ C: 1804x600x720				
	Empty weight (without assembly)	kg	B 185 · C 246	B 193 · C 254	B 185 · C 246	B 193 · C 254	

- Air source/Hybrid source by replacing/combining the ground source circuit by/with one or more ecoGEO+ AU. Consult the ecoGEO+ AU manual for more detailed information.
- In compliance with EN 14511, this includes the consumption of the circulation pumps and the compressor driver.
- Considering brine and production flow rates in compliance with EN 14511.
- Considering a heat slope from 20°C to 50°C in absence of consumption.
- Considering support provided by the emergency electrical heater or the HTR system. Maximum DHW temperature with the HTR system can be limited by the compressor discharge temperature.
- In compliance with EN 12102, this includes the acoustic insulation kit of the compressor.
- Starting current depends on the working conditions of the hydraulic circuits.
- The admissible voltage range for proper operation of the heat pump is ±10%.
- Maximum consumption can vary significantly according to working conditions, or if the compressor's operation range is restricted. Consult the technical service manual for more detailed information.
- Certification in process.

Dimensions and hydraulic connections

Operational chart

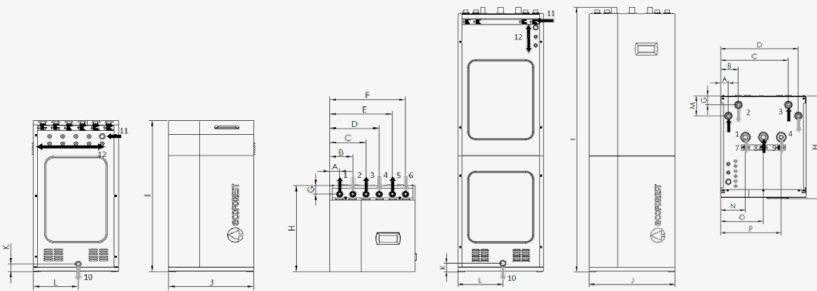

MODEL	DIMENSIONS (mm)															
	A	B	C	D	E	F	G	H	I	J	K	L	M	N	O	P
ecoGEO+ Basic	55	153	251	349	447	545	70	710	1058	600	61	300	-	-	-	-
ecoGEO+ Compact	55	125	475	545	-	-	62	720	1851	600	58	315	140	175	300	425

1. Heating/Cooling Outlet - 1 1/4" M
2. Heating/Cooling Inlet - 1 1/4" M
3. Brine Outlet - 1 1/4" M
4. Brine Inlet - 1 1/4" M
5. DHW System Outlet - 1 1/4" M
6. DHW System Inlet - 1 1/4" M
7. DCW Inlet - 1" F
8. DHW Outlet - 1" F
9. DHW Recirculation Inlet - 3/4" F
10. Drain - 16 mm

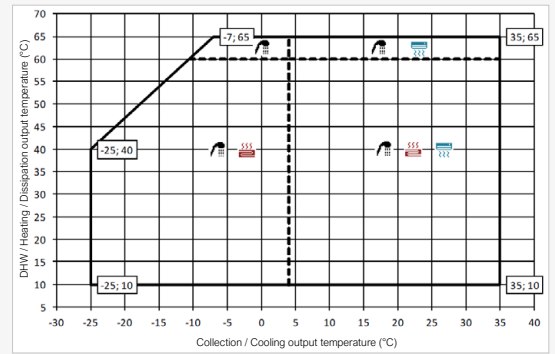

Installation management

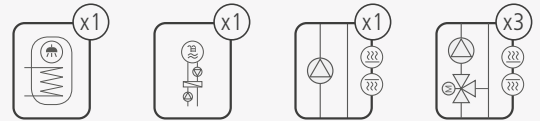

Performance curves

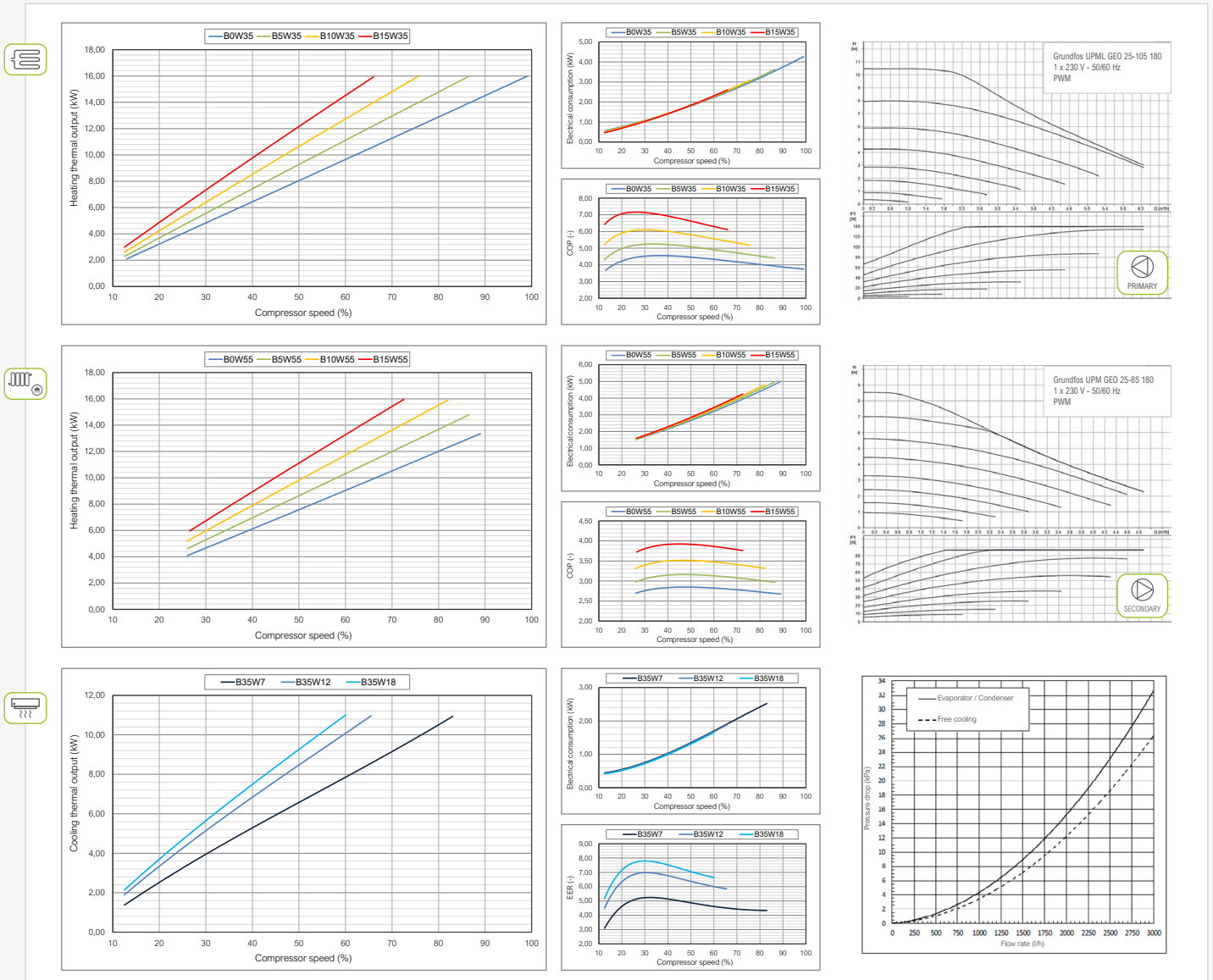

ecoGEO+ B/C 5-22

- Modulating thermal power control within a wide range (20-100%) and modulating flow rate control of both brine and production circuits (20-100%).
- Inverter technology and scroll compressor.
- Compact design including brine and production circulation pumps, brine and production expansion vessels (8l and 12l respectively), brine and production safety valves and DHW three-way valve.
- High Temperature Recovery system (HTR) for DHW production up to 70 °C without electrical support and simultaneous production of DHW and heating/cooling.
- Integrated management of up to 4 different emission temperatures, 2 buffer tanks (heating and cooling), 1 DHW tank, 1 pool and hourly control of DHW recirculation.
- Integrated management of aerothermal collection modulating units, in case of air source or hybrid configurations.
- Integrated management of external On/Off or modulating auxiliary systems, such as electrical heaters, On/Off boilers or modulating boilers.
- Integrated management of cascade systems up to 3 units.
- Integrated management of simultaneous cooling/heating systems according to scheme.
- Integrated free cooling in models 2 and 4.
- Integrated active cooling in models 3 and 4.
- Single-phase and Three-phase versions available.
- Integrated photovoltaic hybridisation.
- Integrated energy meters to measure the electrical consumption, the heating/cooling thermal power, the COP and the monthly and annual SPF.

SPECIFICATIONS ecoGEO+ B/C 5-22		UNITS	B1/C1	B2/C2	B3/C3	B4/C4	
APPLICATION	Place of installation	-	Indoors				
	Type of brine system ¹	-	Ground source / Air source / Hybrid source				
	DHW, Heating and Pool	-	✓	✓	✓	✓	
	High Temperature Recovery (HTR) system option	-	✓	✓	✓ by default	✓ by default	
	Integrated Active cooling	-	-	-	✓	✓	
PERFORMANCE	Integrated Passive cooling	-	-	✓	-	✓	
	Modulation range of the compressor	%	20 to 100				
	Heating power output ² , B0W35	kW	4,0 to 22,8				
	COP ² , B0W35	-	4,9				
	Active cooling power output ² , B35W7	kW	-	4,2 to 22,0			
	EER ² , B35W7	-	-	5,4			
	Max. DHW temperature without / with support ⁵	°C	63 / 70				
	Noise power emission level ⁶	db	35 to 46				
	Energy label / rjs / SCOP W35 average climate control	-	A+++ / 184% / 4,80				
	Energy label / rjs / SCOP W55 average climate control	-	A++ / 146% / 3,85				
OPERATION LIMITS	Distribution / Set heating outlet temperature range	°C	10 to 60 / 20 to 60				
	Distribution / Set cooling outlet temperature range	°C	4 to 35 / 7 to 25				
	Brine inlet temperature range in heating applications	°C	-25 to 35				
	Brine inlet temperature range in cooling applications	°C	10 to 60				
	Minimum / Maximum refrigerant circuit pressure	bar	2 / 45				
	Production / Pre-load circuit pressure	bar	0,5 to 3,0 / 1,5				
	Brine / Pre-load circuit pressure	bar	0,5 to 3,0 / 0,7				
	Volume / Max. DHW storage tank pressure (ecoGEO+ C)	l / bar	165 / 8				
WORKING FLUIDS	R410A Refrigerant load without HTR / with HTR	kg	1,4		1,5		
	Compressor oil type / load	kg	POE / 1,18				
CONTROL ELECTRICAL DATA	1/N/PE 230 V / 50-60 Hz ⁸	-	✓				
	Maximum recommended external protection ⁹	-	C16A				
	Transformer primary circuit fuse	A	0,5				
	Transformer secondary circuit fuse	A	2,5				
ELECTRICAL DATA: SINGLE-PHASE	1/N/PE 230 V / 50-60 Hz ⁸	-	✓				
	Maximum recommended external protection ⁹	-	C32A				
	Maximum consumption ² , B0W35	kW / A	5,5 / 23,9				
	Maximum consumption ² , B0W55	kW / A	5,5 / 23,9				
	Minimum / Maximum starting current ⁷	A	2,6 / 12,5				
	Correction of cosine Ø	-	0,96/1				
ELECTRICAL DATA: THREE-PHASE	3/N/PE 400 V / 50-60Hz ⁸	-	✓				
	Maximum recommended external protection ⁹	-	C13A				
	Maximum consumption ² , B0W35	kW / A	6,0 / 8,7				
	Maximum consumption ² , B0W55	kW / A	6,0 / 8,7				
	Minimum / Maximum starting current ⁷	A	0,9 / 4,2				
	Correction of cosine Ø	-	0,96/1				
DIMENSIONS/WEIGHT	Height x width x depth	mm	ecoGEO+ B: 1060x600x710 · ecoGEO+ C: 1804x600x720				
	Empty weight (without assembly)	kg	B 185 · C 247	B 193 · C 255	B 185 · C 247	B 193 · C 255	

1. Air source/Hybrid source by replacing/combining the ground source circuit by/with one or more ecoGEO+ AU. Consult the ecoGEO+ AU manual for more detailed information.

2. In compliance with EN 14511, this includes the consumption of the circulation pumps and the compressor driver.

3. Considering brine and production flow rates in compliance with EN 14511.

4. Considering a heat slope from 20°C to 50°C in absence of consumption.

5. Considering support provided by the emergency electrical heater or the HTR system. Maximum DHW temperature with the HTR system can be limited by

the compressor discharge temperature.

6. In compliance with EN 12102, this includes the acoustic insulation kit of the compressor.

7. Starting current depends on the working conditions of the hydraulic circuits.

8. The admissible voltage range for proper operation of the heat pump is ±10%.

9. Maximum consumption can vary significantly according to working conditions, or if the compressor's operation range is restricted. Consult the technical service manual for more detailed information.

10. Certification in process.

Dimensions and hydraulic connections

Operational chart

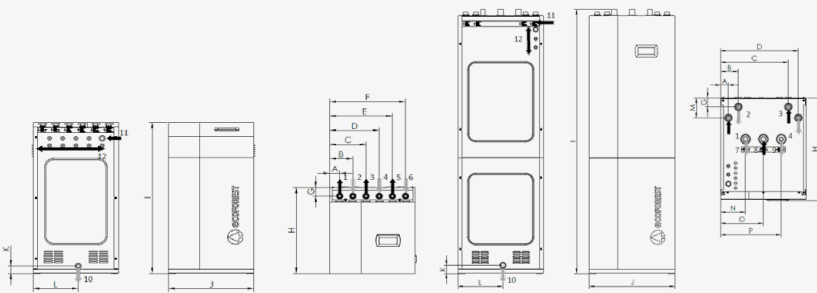

MODEL	DIMENSIONS (mm)															
	A	B	C	D	E	F	G	H	I	J	K	L	M	N	O	P
ecoGEO+ Basic	55	153	251	349	447	545	70	710	1058	600	61	300	-	-	-	-
ecoGEO+ Compact	55	125	475	545	-	-	62	720	1851	600	58	315	140	175	300	425

1. Heating/Cooling Outlet - 1 1/4" M
2. Heating/Cooling Inlet - 1 1/4" M
3. Brine Outlet - 1 1/4" M
4. Brine Inlet - 1 1/4" M
5. DHW System Outlet - 1 1/4" M
6. DHW System Inlet - 1 1/4" M
7. DCW Inlet - 1" F
8. DHW Outlet - 1" F
9. DHW Recirculation Inlet - 3/4" F
10. Drain - 16 mm

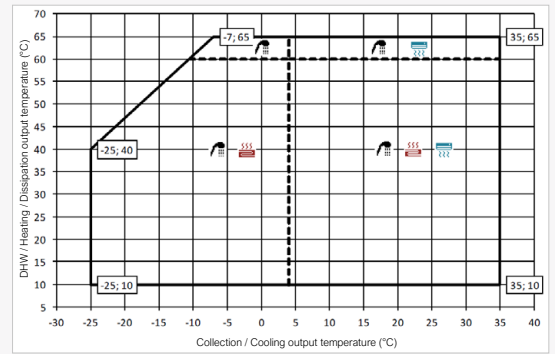

Installation management

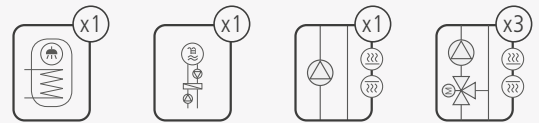

Performance curves

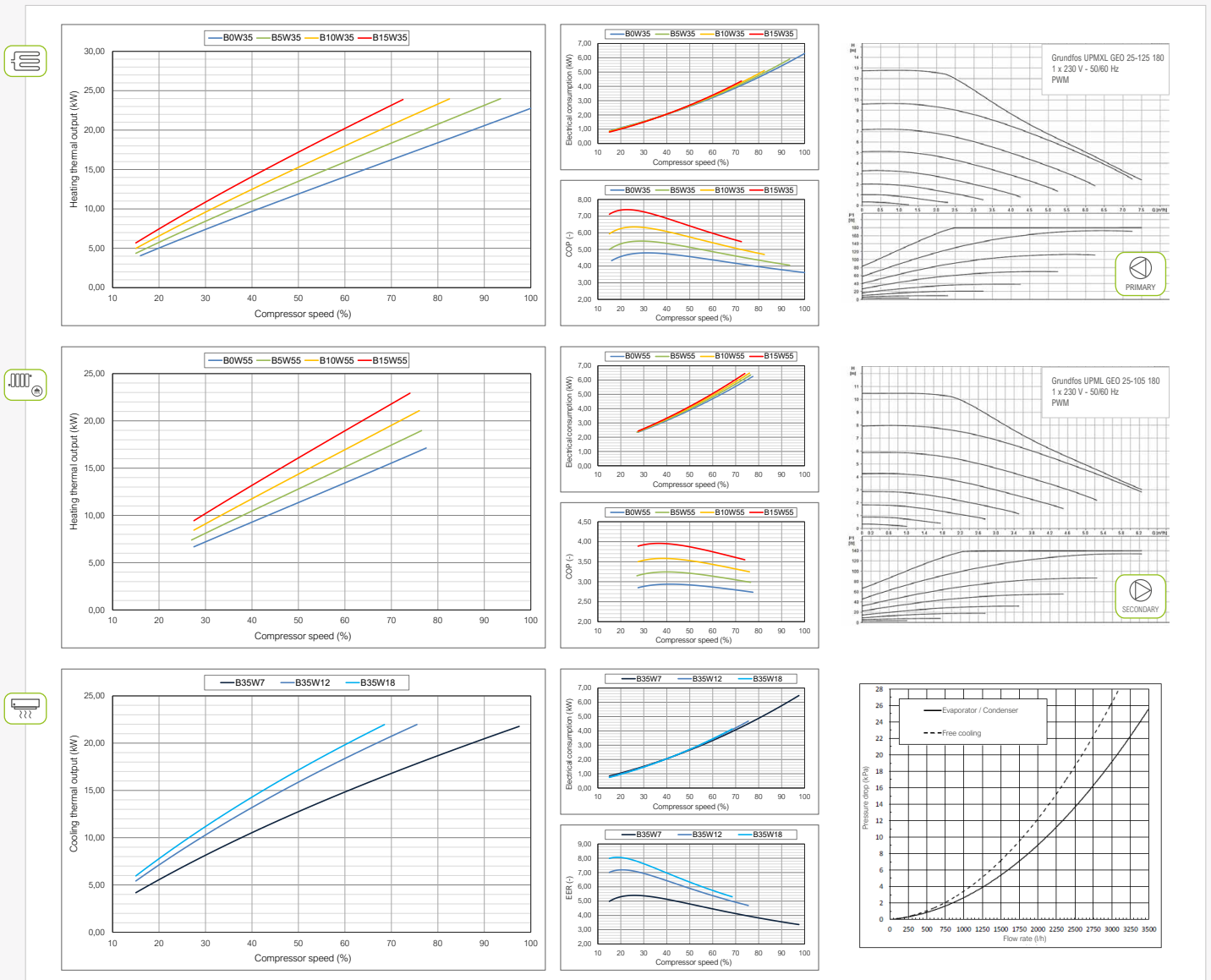

ecoGEO+ HP

High Power range



Power ranges

ecoGEO+ 12-40 kW

ecoGEO+ 15-70 kW

ecoGEO+ 25-100 kW

Cascade



Services



DHW



Heating



Cooling



Pool

Models

ecoGEO+ HP1

- DHW
- Heating
- Pool
- Free Cooling*

ecoGEO+ HP3

- DHW
- Heating
- Pool
- Free Cooling*
- Active Cooling

* External free cooling management



Inverter technology

Power ranges: 12-40 kW / 15-70 kW / 25-100 kW

Domestic hot water production

Heating and pool production

Integrated active cooling production

External passive (free) cooling production management

Internet connection through the ecoSMART Easynet

Integrated photovoltaic hybridisation

Simultaneous heating and cooling production

Hybrid source management through ecoSMART e-source

Cascade management up to 6 units through cascade manager ecoSMART Supervisor

Three-phase (400V) power supply

Collection system



Ground



Open loop



Air



Hybrid



ecoGEO+ HP 12-40

- Modulating thermal power control within a wide range (25-100%) and modulating flow rate control of both brine and production circuits (20-100%).
- Inverter technology and scroll compressor.
- Integrated management of up to 5 different emission temperatures, 2 buffer tanks (heating and cooling), 1 DHW tank, 1 pool and hourly control of DHW recirculation.
- Management of aerothermal collection modulating units, in case of air source or hybrid configurations by means of the ecoSMART e-source.
- Integrated management of external On/Off or modulating auxiliary systems, such as electrical heaters, On/Off boilers or modulating boilers.
- Management of cascade systems up to 6 units by means of the ecoSMART Supervisor.
- Integrated management of simultaneous cooling/heating systems according to scheme.
- Free cooling (Passive cooling) management.
- Integrated active cooling in models 3.
- Three-phase version available.
- Integrated photovoltaic hybridisation.
- Integrated energy meters to measure the electrical consumption, the heating/cooling thermal power, the COP and the monthly and annual SPF.

SPECIFICATIONS ecoGEO+ HP 12-40		UNITS	HP1	HP3
APPLICATION	Place of installation	-	Indoors	
	Type of brine system ¹	-	Ground source / Air source / Hybrid source	
	DHW with external tank	-	✓	✓
	Heating and Pool	-	✓	✓
	External Passive cooling management	-	✓	✓
PERFORMANCE	Integrated Active cooling	-	-	✓
	Modulation range of the compressor	%	25 to 100	
	Heating power output ¹ , B0W35	kW	10,7 to 44,6	
	COP ¹ , B0W35	-	4,6	
	Active cooling power output ¹ , B35W7	kW	-	11,3 to 45,8
	EER ¹ , B35W7	-	-	4,4
	Max. DHW temperature without / with support	°C	60 / 70	
	Noise power emission level ³	db	53 to 71	
	Energy label / rjs / SCOP W35 average climate control	-	A+++ / 175% / 4,58	
	Energy label / rjs / SCOP W55 average climate control	-	A++ / 136% / 3,59	
OPERATION LIMITS	Distribution / Set heating outlet temperature range ²	°C	10 to 60 / 20 to 60	
	Distribution / Set cooling outlet temperature range ²	°C	5 to 35 / 7 to 25	
	Brine inlet temperature range in heating applications ²	°C	-20 to 35	
	Brine inlet temperature range in cooling applications ²	°C	10 to 60	
	Minimum / Maximum refrigerant circuit pressure	bar	2 / 45	
	Production / Pre-load circuit pressure	bar	0,5 to 5,0	
	Brine / Pre-load circuit pressure	bar	0,5 to 5,0	
WORKING FLUIDS	R410A Refrigerant load	kg	4,1	4,4
	Compressor oil type / load	kg	POE / 3,3	
	Nominal primary flow rate, B0W35 ¹ (ΔT = 3 °C)	l/h	2405 to 9830	
	Nominal secondary flow rate, B0W35 ¹ (ΔT = 5 °C)	l/h	1845 to 7685	
CONTROL ELECTRICAL DATA	1/N/PE 230 V / 50-60 Hz ⁵	-	✓	
	Maximum recommended external protection ⁷	-	C1A	
	Transformer primary circuit fuse	A	0,63	
	Transformer secondary circuit fuse	A	4,0	
ELECTRICAL DATA: THREE-PHASE	3/N/PE 400 V / 50-60Hz ⁵	-	✓	
	Maximum recommended external protection ⁷	-	C40A	
	Maximum consumption ² , B0W35	kW / A	10,9 / 17,7	
	Maximum consumption ² , B0W55	kW / A	15,5 / 24,6	
	Minimum / Maximum starting current ⁴	A	5,6 / 9,0	
DIMENSIONS/WEIGHT	Correction of cosine Ø	-	0,96/1	
	Height x width x depth	mm	1063x870x785	
	Empty weight (without assembly)	kg	280	285

1. In compliance with EN 14511, this includes the consumption of the circulation pumps and the compressor driver.

2. With variable speed circulating pumps, managed by the ecoGEO+ HP heat pump.

3. According to EN 12102.

4. Starting current depends on working condition of the hydraulic circuits.

5. The admissible voltage range for proper operation of the heat pump is ±10%.

6. Maximum consumption can vary significantly according to working conditions, or if the compressor's range of operation is restricted.

7. External protection exclusively regarding the ecoGEO+ heat pump controller electrical consumption. This protection should be updated in

case of using the controller single-phase electrical supply to wire other equipments depending on the features of such equipments.

8. In case of air source or hybrid source configuration, it is required to combine the ecoGEO+ HP heat pump with the ecoSMART e-source.

Note: primary circuit and secondary circuit circulation pumps not included.

Dimensions and hydraulic connections

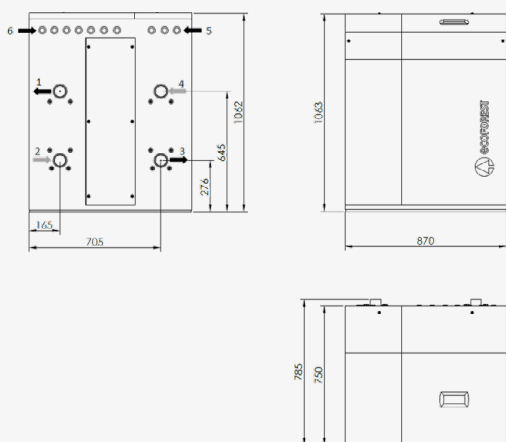

1. Secondary Outlet - 2" M
2. Secondary Inlet - 2" M
3. Primary Outlet - 2" M
4. Primary Inlet - 2" M

Operational chart

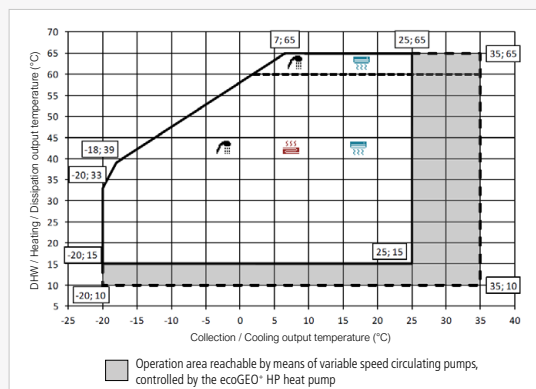

Installation management

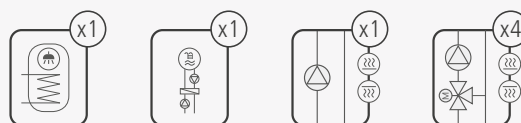

Performance curves

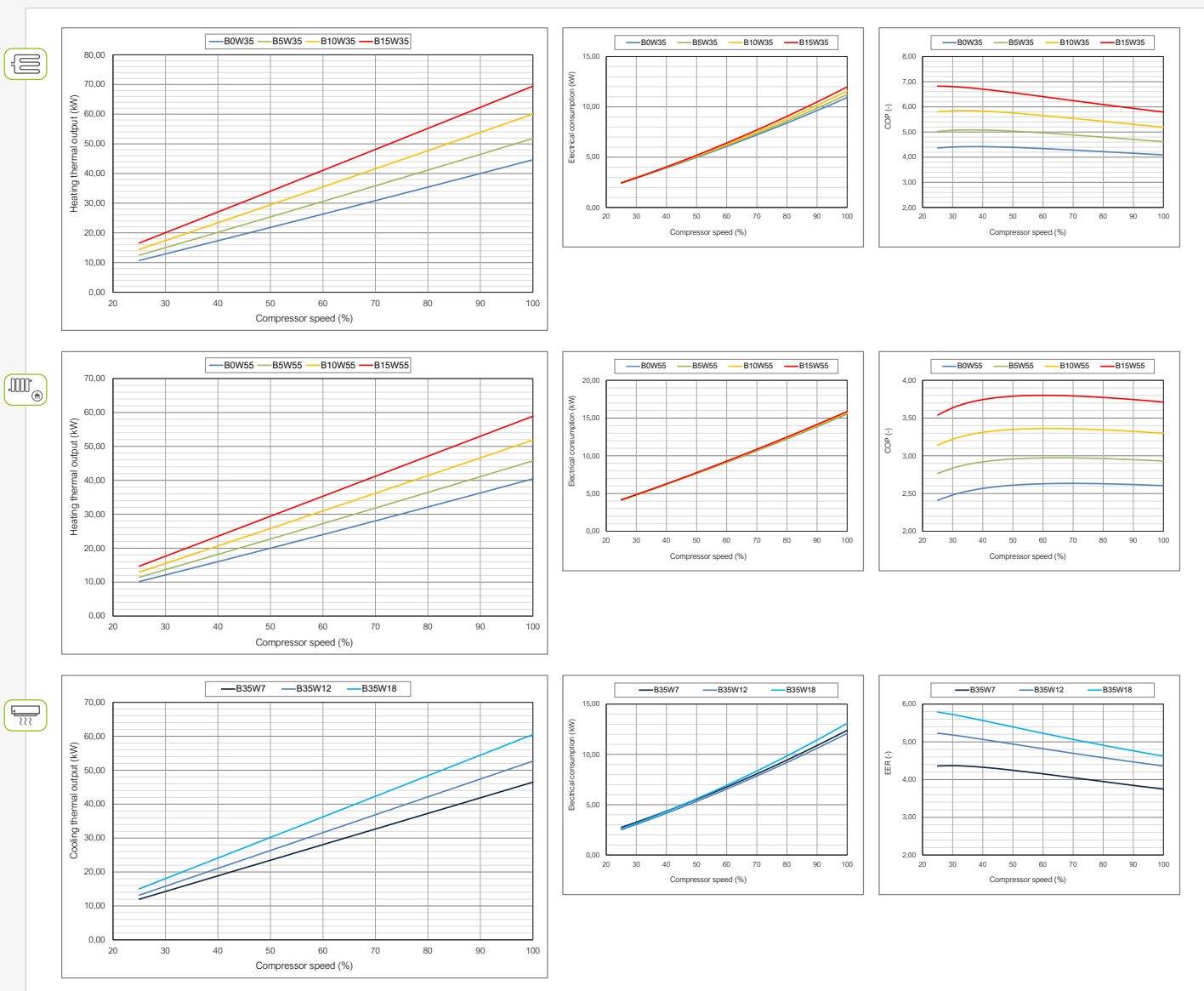

ecoGEO+ HP 15-70

- Modulating thermal power control within a wide range (25-100%) and modulating flow rate control of both brine and production circuits (20-100%).
- Inverter technology and scroll compressor.
- Integrated management of up to 5 different emission temperatures, 2 buffer tanks (heating and cooling), 1 DHW tank, 1 pool and hourly control of DHW recirculation.
- Management of aerothermal collection modulating units, in case of air source or hybrid configurations by means of the ecoSMART e-source.
- Integrated management of external On/Off or modulating auxiliary systems, such as electrical heaters, On/Off boilers or modulating boilers.
- Management of cascade systems up to 6 units by means of the ecoSMART Supervisor.
- Integrated management of simultaneous cooling/heating systems according to scheme.
- Free cooling (Passive cooling) management.
- Integrated active cooling in models 3.
- Three-phase version available.
- Integrated photovoltaic hybridisation.
- Integrated energy meters to measure the electrical consumption, the heating/cooling thermal power, the COP and the monthly and annual SPF.

SPECIFICATIONS ecoGEO+ HP 15-70		UNITS	HP1	HP3
APPLICATION	Place of installation	-	Indoors	
	Type of brine system ¹	-	Ground source / Air source / Hybrid source	
	DHW with external tank	-	✓	✓
	Heating and Pool	-	✓	✓
	External Passive cooling management	-	✓	✓
PERFORMANCE	Integrated Active cooling	-	-	✓
	Modulation range of the compressor	%	25 to 100	
	Heating power output ¹ , B0W35	kW	17,1 to 59,6	
	COP ¹ , B0W35	-	4,5	
	Active cooling power output ¹ , B35W7	kW	-	15,1 to 61,5
	EER ¹ , B35W7	-	-	4,5
	Max. DHW temperature without / with support	°C	60 / 70	
	Noise power emission level ³	db	53 to 71	
	Energy label / r/s / SCOP W35 average climate control	-	A+++ / 180% / 4,71	
	Energy label / r/s / SCOP W55 average climate control	-	A++ / 139% / 3,67	
OPERATION LIMITS	Distribution / Set heating outlet temperature range ²	°C	10 to 60 / 20 to 60	
	Distribution / Set cooling outlet temperature range ²	°C	5 to 35 / 7 to 25	
	Brine inlet temperature range in heating applications ²	°C	-20 to 35	
	Brine inlet temperature range in cooling applications ²	°C	10 to 60	
	Minimum / Maximum refrigerant circuit pressure	bar	2 / 45	
	Production / Pre-load circuit pressure	bar	0,5 to 5,0	
	Brine / Pre-load circuit pressure	bar	0,5 to 5,0	
WORKING FLUIDS	R410A Refrigerant load	kg	4,7	5,5
	Compressor oil type / load	kg	POE / 3,6	
	Nominal primary flow rate, B0W35 ¹ (ΔT = 3 °C)	l/h	3230 to 13195	
	Nominal secondary flow rate, B0W35 ¹ (ΔT = 5 °C)	l/h	2465 to 10265	
CONTROL ELECTRICAL DATA	1/N/PE 230 V / 50-60 Hz ⁵	-	✓	
	Maximum recommended external protection ⁷	-	C1A	
	Transformer primary circuit fuse	A	0,63	
	Transformer secondary circuit fuse	A	4,0	
ELECTRICAL DATA: THREE-PHASE	3/N/PE 400 V / 50-60Hz ⁵	-	✓	
	Maximum recommended external protection ⁷	-	C50A	
	Maximum consumption ² , B0W35	kW / A	14,3 / 23,2	
	Maximum consumption ² , B0W55	kW / A	20,4 / 32,3	
	Minimum / Maximum starting current ⁴	A	7,5 / 11,8	
DIMENSIONS/WEIGHT	Correction of cosine Ø	-	0,96/1	
	Height x width x depth	mm	1063x870x785	
	Empty weight (without assembly)	kg	320	325

1. In compliance with EN 14511, this includes the consumption of the circulation pumps and the compressor driver.

2. With variable speed circulating pumps, managed by the ecoGEO+ HP heat pump.

3. According to EN 12102.

4. Starting current depends on working condition of the hydraulic circuits.

5. The admissible voltage range for proper operation of the heat pump is ±10%.

6. Maximum consumption can vary significantly according to working conditions, or if the compressor's range of operation is restricted.

7. External protection exclusively regarding the ecoGEO+ heat pump controller electrical consumption. This protection should be updated in

case of using the controller single-phase electrical supply to wire other equipments depending on the features of such equipments.

8. In case of air source or hybrid source configuration, it is required to combine the ecoGEO+ HP heat pump with the ecoSMART e-source.

Note: primary circuit and secondary circuit circulation pumps not included.

Dimensions and hydraulic connections

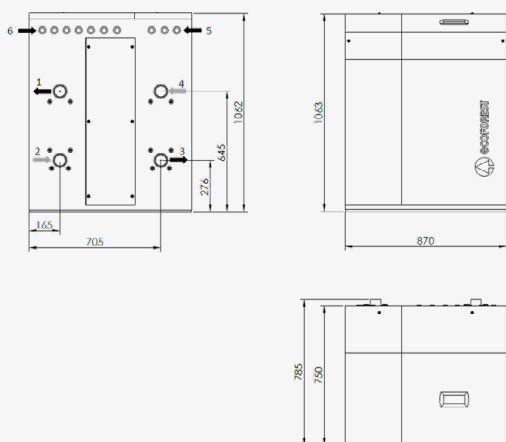

1. Secondary Outlet - 2" M
2. Secondary Inlet - 2" M
3. Primary Outlet - 2" M
4. Primary Inlet - 2" M

Operational chart

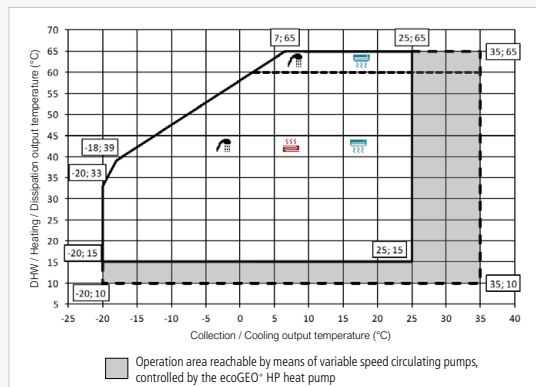

Installation management

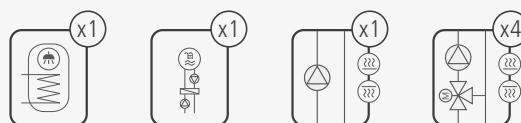

Performance curves

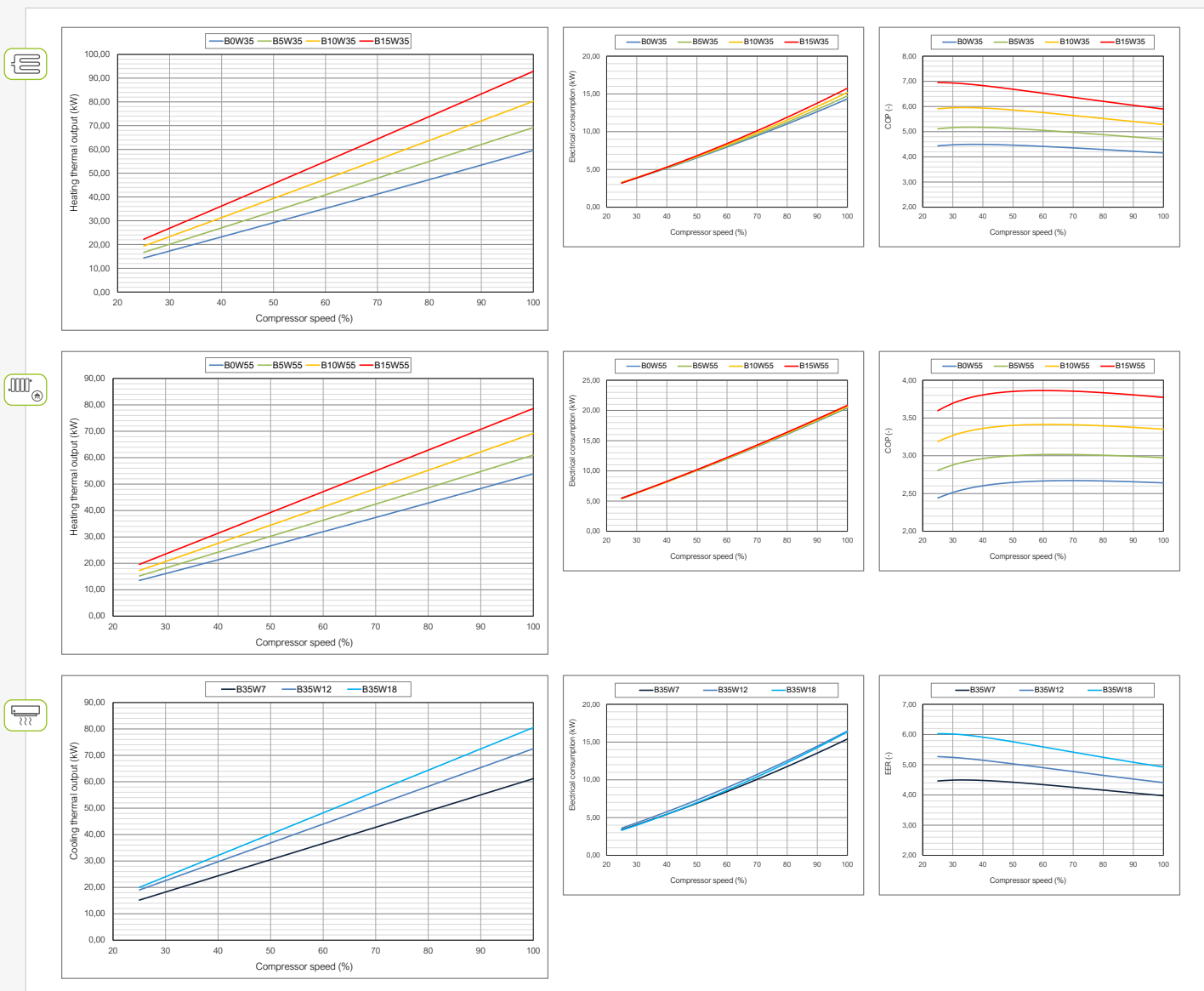

ecoGEO+ HP 25-100

- Modulating thermal power control within a wide range (25-100%) and modulating flow rate control of both brine and production circuits (20-100%).
- Inverter technology and scroll compressor.
- Integrated management of up to 5 different emission temperatures, 2 buffer tanks (heating and cooling), 1 DHW tank, 1 pool and hourly control of DHW recirculation.
- Management of aerothermal collection modulating units, in case of air source or hybrid configurations by means of the ecoSMART e-source.
- Integrated management of external On/Off or modulating auxiliary systems, such as electrical heaters, On/Off boilers or modulating boilers.
- Management of cascade systems up to 6 units by means of the ecoSMART Supervisor.
- Integrated management of simultaneous cooling/heating systems according to scheme.
- Free cooling (Passive cooling) management.
- Integrated active cooling in models 3.
- Three-phase version available.
- Integrated photovoltaic hybridisation.
- Integrated energy meters to measure the electrical consumption, the heating/cooling thermal power, the COP and the monthly and annual SPF.

SPECIFICATIONS ecoGEO+ HP 25-100		UNITS	HP1	HP3
APPLICATION	Place of installation	-	Indoors	
	Type of brine system ¹	-	Ground source / Air source / Hybrid source	
	DHW with external tank	-	✓	✓
	Heating and Pool	-	✓	✓
	External Passive cooling management	-	✓	✓
PERFORMANCE	Integrated Active cooling	-	-	✓
	Modulation range of the compressor	%	25 to 100	
	Heating power output ¹ , B0W35	kW	21,1 to 86,7	
	COP ¹ , B0W35	-	4,5	
	Active cooling power output ¹ , B35W7	kW	-	22,3 to 90,3
	EER ¹ , B35W7	-	-	4,6
	Max. DHW temperature without / with support	°C	60 / 70	
	Noise power emission level ³	db	59 to 72	
	Energy label / r/s / SCOP W35 average climate control	-	A+++ / 186% / 4,84	
	Energy label / r/s / SCOP W55 average climate control	-	A++ / 136% / 3,61	
OPERATION LIMITS	Distribution / Set heating outlet temperature range ²	°C	10 to 60 / 20 to 60	
	Distribution / Set cooling outlet temperature range ²	°C	5 to 35 / 7 to 25	
	Brine inlet temperature range in heating applications ²	°C	-20 to 35	
	Brine inlet temperature range in cooling applications ²	°C	10 to 60	
	Minimum / Maximum refrigerant circuit pressure	bar	2 / 45	
	Production / Pre-load circuit pressure	bar	0,5 to 5,0	
	Brine / Pre-load circuit pressure	bar	0,5 to 5,0	
WORKING FLUIDS	R410A Refrigerant load	kg	8,5	9,1
	Compressor oil type / load	kg	POE / 6,7	
	Nominal primary flow rate, B0W35 ¹ (ΔT = 3 °C)	l/h	4765 to 19360	
	Nominal secondary flow rate, B0W35 ¹ (ΔT = 5 °C)	l/h	3625 to 14935	
CONTROL ELECTRICAL DATA	1/N/PE 230 V / 50-60 Hz ⁵	-	✓	
	Maximum recommended external protection ⁷	-	C1A	
	Transformer primary circuit fuse	A	0,63	
	Transformer secondary circuit fuse	A	4,0	
ELECTRICAL DATA: THREE-PHASE	3/N/PE 400 V / 50-60Hz ⁵	-	✓	
	Maximum recommended external protection ⁷	-	C50A	
	Maximum consumption ² , B0W35	kW / A	20,3 / 31,8	
	Maximum consumption ² , B0W55	kW / A	29,6 / 45,1	
	Minimum / Maximum starting current ⁴	A	10,8 / 16,7	
DIMENSIONS/WEIGHT	Correction of cosine Ø	-	0,96/1	
	Height x width x depth	mm	1063x950x886	
	Empty weight (without assembly)	kg	350	355

1. In compliance with EN 14511, this includes the consumption of the circulation pumps and the compressor driver.

2. With variable speed circulating pumps, managed by the ecoGEO+ HP heat pump.

3. According to EN 12102.

4. Starting current depends on working condition of the hydraulic circuits.

5. The admissible voltage range for proper operation of the heat pump is ±10%.

6. Maximum consumption can vary significantly according to working conditions, or if the compressor's range of operation is restricted.

7. External protection exclusively regarding the ecoGEO+ heat pump controller electrical consumption. This protection should be updated in

case of using the controller single-phase electrical supply to wire other equipments depending on the features of such equipments.

8. In case of air source or hybrid source configuration, it is required to combine the ecoGEO+ HP heat pump with the ecoSMART e-source.

Note: primary circuit and secondary circuit circulation pumps not included.

Dimensions and hydraulic connections

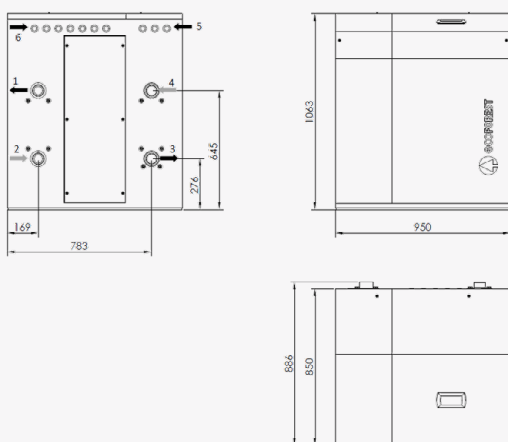

1. Secondary Outlet - 2 1/2" M
2. Secondary Inlet - 2 1/2" M
3. Primary Outlet - 2 1/2" M
4. Primary Inlet - 2 1/2" M

Operational chart

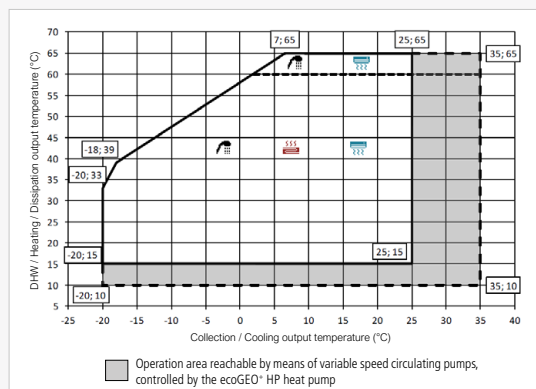

Installation management

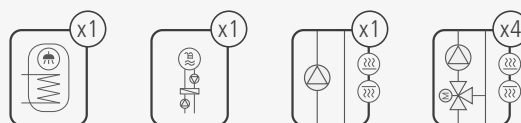

Performance curves

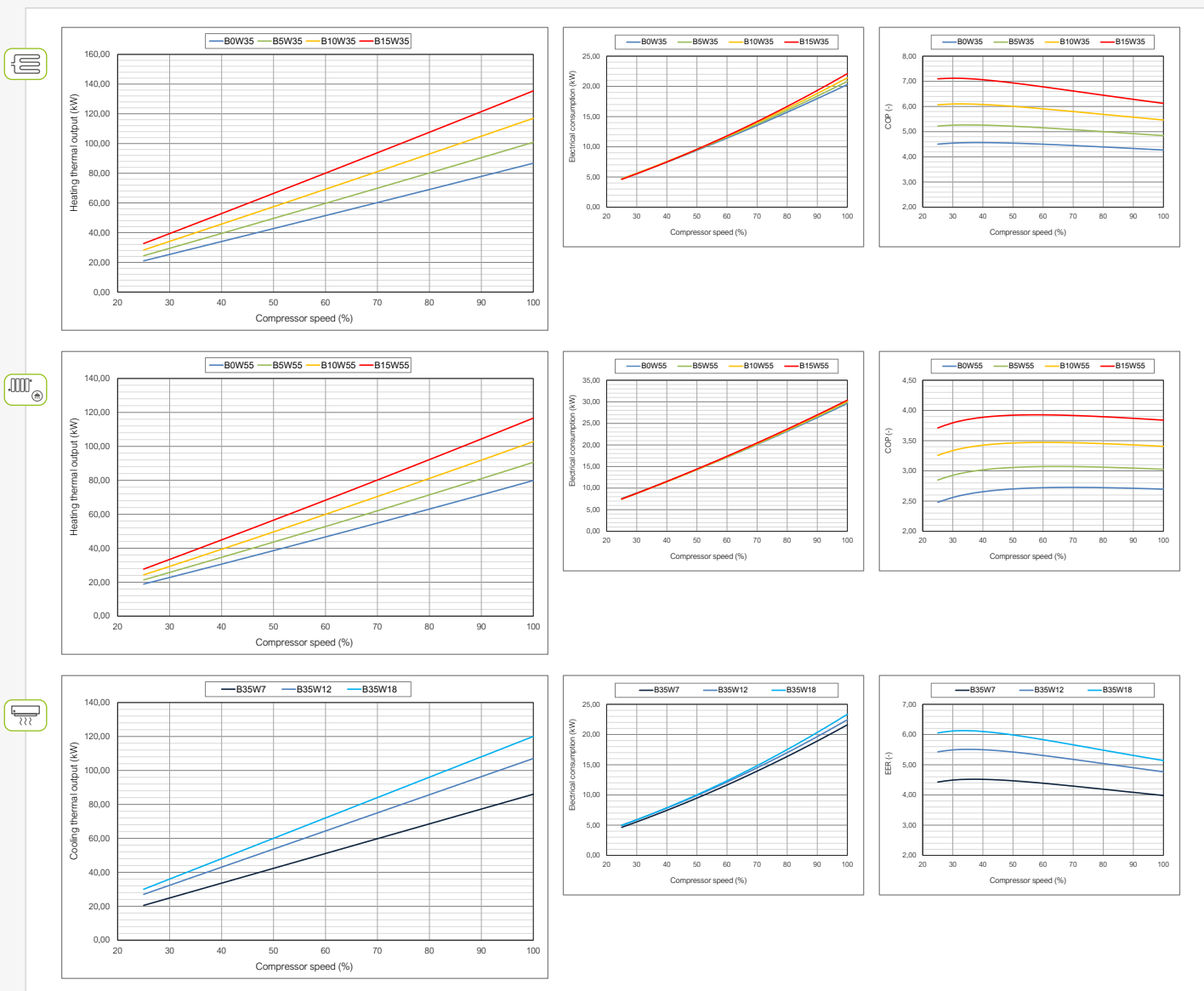

ecoGEO⁺ & AU

Water-to-water air source heat pumps



ecoGEO⁺ & AU

Inverter water-to-water air source, a unique solution

The ecoGEO⁺ range is the Ecoforest range of water-to-water heat pumps. These heat pumps, both domestic and high power, are compatible with aérothermal collection systems and even with hybrid aérothermal-geothermal collection systems. Likewise, they are also capable of offering all the services required in a HVAC system in an integrated way: DHW, Heating, Pool and Active Cooling.



All ecoGEO⁺ heat pumps make use of Inverter technology, which allows them to modulate their power in order to adapt to the thermal demands of the installation with the highest efficiency. This translates into a very considerable reduction in electrical consumption and great savings. In addition, this air source solution presents a series of considerable advantages compared to conventional aérothermal units: a lower acoustic emission level, a unique defrost system that results in higher seasonal performance, and an easier installation. Thanks to the technology and control strategies developed by Ecoforest, the installation of ecoGEO⁺ heat pumps also becomes simpler, more compact and cheaper than those of other heat pumps on the market, since it allows to dispense with certain components that would be necessary in traditional heat pump installations.

ecoGEO+ Basic/Compact & AU

Residential range



Power ranges

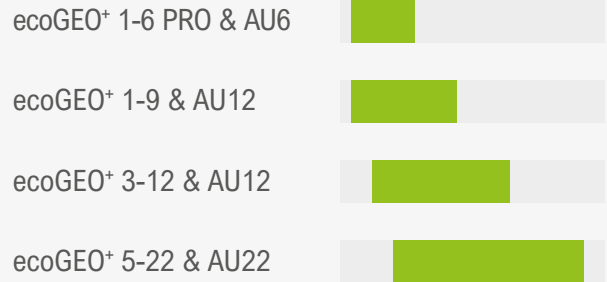

Cascade

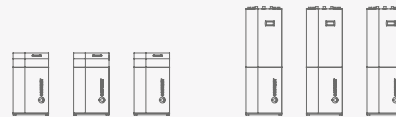

Services



DHW



Heating



Cooling



Pool

Models

ecoGEO+ B2/C2 & AU

DHW
Heating
Pool

ecoGEO+ B4/C4 & AU

DHW
Heating
Pool
Active Cooling



Inverter technology

Power ranges: 1-6 kW / 1-9 kW / 3-12 kW / 5-22 kW

Domestic hot water production

Heating and pool production

Integrated active cooling production

Modulating speed hydraulic aérothermal unit

Internet connection through the ecoSMART Easynet

Integrated photovoltaic hybridisation

HTR technology for DHW production up to 70°C and simultaneous production of several services

Natural refrigerant used in ecoGEO+ PRO models allowing DHW production temperature up to 75°C

Integrated cascade management up to 3 units

Single-phase (230V) or three-phase (400V) power supply

Exclusive performances



ecoGEO+ defrost system



Minimum sound level



Limitless layout



Greater lifespan



Outdoor aerothermal units

AU6 / AU12 / AU22

- Outdoor aerothermal units.
- Compatibles with ecoGEO+ B2/C2/B4/C4 models.
- Modulating collection thermal power control by means of the modulation of the fan speed (25-100%) and the modulation of the flow rate control of the brine circulation pump (20-100%).
- Exclusively hydraulic **air source system allowing** to replace a geothermal collection system by an aerothermal or a hybrid geothermal-aerothermal system.
- ecoGEO+ defrost system: defrosting without starting the compressor or activating electrical support systems.
- Working condition as collection system as well as dissipation system.
- Enhanced lifespan of the heat pump, which is placed indoors, compared to outdoor conventional monobloc or biblock units.
- Selection of the defrosting energy source: the ecoGEO+ control strategies allow to select the energy source for defrosting cycles depending of the installation features (DHW tank, heating buffer tank, pool, ...).

SPECIFICATIONS AU		UNITS	AU6	AU12	AU22
COMPATIBILITY AND DIMENSIONING	ecoGEO+ compatible models ¹	-	B2 / C2 / B4 / C4		
	Aerothermal collection with ecoGEO+ 1-6 kW PRO	-	✓	-	-
	Aerothermal collection with ecoGEO+ 1-9 kW	-	-	✓	-
	Aerothermal collection with ecoGEO+ 3-12 kW	-	-	✓	-
	Aerothermal collection with ecoGEO+ 5-22 kW	-	-	✓	✓
	Hybrid ground-air collection with ecoGEO+ 3-12 kW	-	-	✓	-
DEFROSTING	Hybrid ground-air collection with ecoGEO+ 5-22 kW	-	-	✓	✓
	ecoGEO+ defrosting system ²	-	Source selection: DHW / Heating / Pool		
OPERATION LIMITS	Defrosted water volume per defrosting cycle	l	3	6	12
	Minimum / Maximum outdoor temperature	°C	-12 / 42		
WORKING FLUIDS	Minimum / Maximum working fluid temperature	°C	-18 / 55		
	Recommended working fluid ³	-	Water-propylene glycol mixture		
	Freezing temperature ⁴	°C	-25		
	Filling volume	l	6	19	33
SOUND LEVEL	Maximum pressure	bar	6		
	Sound pressure level ⁵ (L _{pk}) - 2,5 m	dBA	50		
	Sound pressure level ⁵ (L _{pk}) - 5 m	dBA	47		
	Sound pressure level ⁵ (L _{pk}) - 10 m	dBA	40		
ELECTRICAL DATA: SINGLE-PHASE	1/N/PE 230 V / 50-60 Hz ⁶	-	✓		
	Number of fans	-	1	1	2
	Maximum consumption	W / A	140 / 1,15	163 / 1,34	326 / 2,68
	Correction of cosine Ø	-	0,96/1		
HYDRAULIC CONNECTIONS	Working fluid inlet and outlet	-	G1 " M	G1 1/4 " M	G1 1/2 " M
	Drain diameter	mm	15		
DIMENSIONS AND WEIGHT	Height x width x depth	mm	670x790x500	900x1000x600	900x1800x600
	Fan diameter	mm	400	450	450
	Nozzle diameter	mm	540		
	Empty weight (without assembly)	kg	54	92	175

- Air source/Hybrid source by replacing/combining the ground source circuit by/with one or more ecoGEO+ AU. Consult the ecoGEO+ AU manual for more detailed information.
- Compressor turned off. Defrosting cycle by means of the thermal energy directly taken from the DHW tank, heating tank or pool. Compatible with the ecoGEO+ B2/B4/C2/C4 heat pump models.
- Consult local regulations before selecting the antifreeze for the working fluid mixture.
- Adapt the freezing temperature to the type of installation and the location climatic conditions and configure the corresponding protections. Prepare the antifreeze-water mixture in the right proportions depending on the required freezing temperature.
- Sound pressure level calculated in compliance with UNE-EN-ISO 3746:2010, maximum fan speed conditions in default configuration settings.
- Admissible voltage for the correct operation of the unit: ±10%.

Dimensions and hydraulic connections

Outdoor unit - AU

AU6

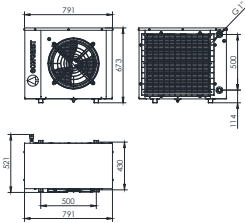

Brine Outlet - 1" M
Brine Inlet - 1" M
Drain - 15 mm

AU12

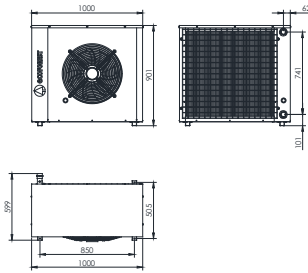

Brine Outlet - 1 1/4" M
Brine Inlet - 1 1/4" M
Drain - 15 mm

AU22

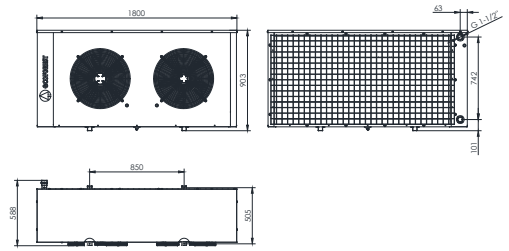

Brine Outlet - 1 1/2" M
Brine Inlet - 1 1/2" M
Drain - 15 mm

Layout and pressure drop

Hydraulic configurations

ecoGEO+ B/C PRO & AU

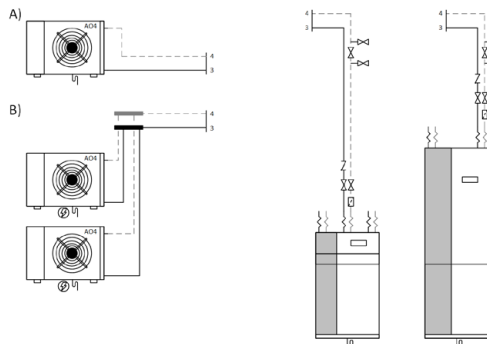

3. Brine Outlet
4. Brine Inlet

ecoGEO+ B/C & AU

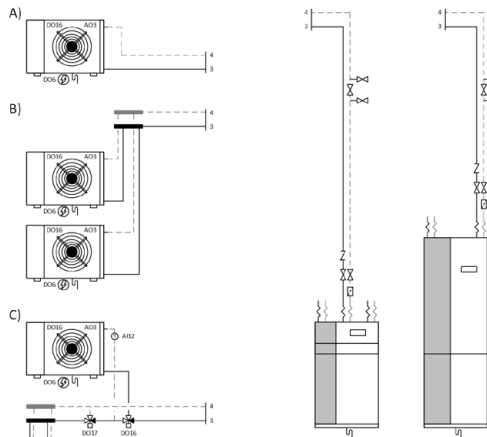

3. Brine Outlet
4. Brine Inlet

Service areas

Single AU

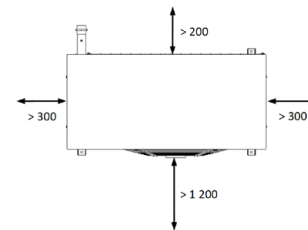

Several AUs in parallel

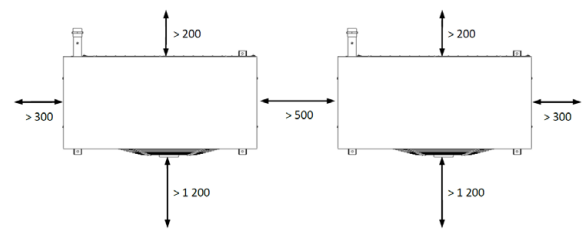

Pressure drops

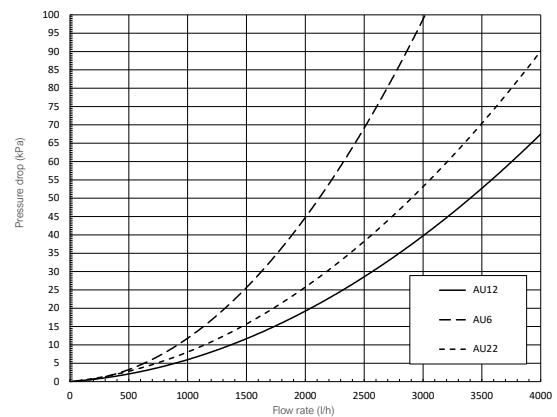

ecoGEO+ B/C 1-6 PRO & AU6



- Modulating thermal power control within a wide range (15-100%) and modulating flow rate control of both brine and production circuits (20-100%).
- Natural refrigerant R290 : GWP 3.
- Inverter technology.
- Compact design including brine and production circulation pumps, brine and production expansion vessels (8l and 12l respectively), brine and production safety valves and DHW three-way valve.
- Integrated management of up to 2 different emission temperatures, 2 buffer tanks (heating and cooling), 1 DHW tank, 1 pool and hourly control of DHW recirculation.
- Integrated management of aerothermal collection modulating units, in case of air source or hybrid configurations.
- Integrated management of external On/Off or modulating auxiliary systems, such as electrical heaters, On/Off boilers or modulating boilers.
- Exclusive defrosting system.
- Integrated active cooling in models 4.
- Single-phase version available.
- Integrated photovoltaic hybridisation.
- Integrated energy meters to measure the electrical consumption, the heating/cooling thermal power, the COP and the monthly and annual SPF.

SPECIFICATIONS ecoGEO+ B/C 1-6 PRO & AU6		UNITS	B2/C2	B4/C4
APPLICATION	Place of installation	-	Indoors: ecoGEO+ 1-6 PRO - Outdoors: AU6	
	Type of brine system ¹	-	Air source / Hybrid source	
	DHW, Heating and Pool	-	✓	✓
	High Temperature Recovery (HTR) system option	-	-	-
	Integrated Active cooling	-	-	✓
PERFORMANCE	Integrated ecoGEO+ defrosting system	-	✓	✓
	Modulation range of the compressor	%	15 to 100	
	Heating power output ^{2, 10} , A7W35	kW	1,0 to 5,8	
	COP ^{2, 10} , A7W35	-	4,7	
	Active cooling power output ^{2, 10} , A35W7	kW	-	1,0 to 5,4
	EER ^{2, 10} , A35W7	-	-	3,7
	Max. DHW temperature without / with support ⁵	°C	75 / 80	
	Noise power emission level ^{6, 10}	db	33 to 44	
	Energy label / rjs / SCOP W35 average climate control	-	A++ / 145% / 3,70	
	Energy label / rjs / SCOP W55 average climate control	-	A+ / 115% / 2,94	
OPERATION LIMITS	Distribution / Set heating outlet temperature range	°C	10 to 75 / 20 to 75	
	Distribution / Set cooling outlet temperature range	°C	-	4 to 35 / 7 to 25
	Brine inlet temperature range in heating applications	°C	-25 to 35	
	Brine inlet temperature range in cooling applications	°C	-	10 to 75
	Minimum / Maximum refrigerant circuit pressure	bar	0,7 / 31,5	
	Production / Pre-load circuit pressure	bar	0,5 to 3,0 / 1,5	
	Brine / Pre-load circuit pressure	bar	0,5 to 3,0 / 0,7	
WORKING FLUIDS	Volume / Max. DHW storage tank pressure (ecoGEO+ C)	l / bar	165 / 8	
	R290 Refrigerant load	kg	0,15	
	Compressor oil type / load	kg	PZ46M / 0,3	
CONTROL ELECTRICAL DATA	1/N/PE 230 V / 50-60 Hz ⁸	-	✓	
	Maximum recommended external protection ⁹	-	C10A	
	Transformer primary circuit fuse	A	0,5	
ELECTRICAL DATA: SINGLE-PHASE	Transformer secondary circuit fuse	A	2,5	
	1/N/PE 230 V / 50-60 Hz ⁸	-	✓	
	Maximum recommended external protection ⁹	-	C25A	
	Maximum consumption ² , A7W35	kW / A	1,6 / 6,8	
	Maximum consumption ² , A7W55	kW / A	2,0 / 8,6	
DIMENSIONS/WEIGHT	Minimum / Maximum starting current ⁷	A	0,6 / 1,8	
	Correction of cosine Ø	-	0,96/1	
DIMENSIONS/WEIGHT	Height x width x depth	mm	ecoGEO+ B: 1060x550x602 · ecoGEO+ C: 1804x600x720 / AU6: 670x790x500	
	Empty weight (without assembly)	kg	ecoGEO+ B: 133 · ecoGEO+ C: 194 / AU6: 54	

- Air source by replacing the ground source circuit by one or more ecoGEO+ AU air units. Consult the ecoGEO+ AU aerothermal units manual for more detailed information.
- In compliance with EN 14511, this includes the consumption of the circulation pumps and the compressor driver.
- Considering brine and production flow rates in compliance with EN 14511.
- Considering a heat slope from 20°C to 50°C in absence of consumption.
- Considering support provided by the emergency electrical heater.
- In compliance with EN 12102, this includes the acoustic insulation kit of the compressor.
- Starting current depends on the working conditions of the hydraulic circuits.
- The admissible voltage range for proper operation of the heat pump is ±10%.
- Maximum consumption can vary significantly according to working conditions, or if the compressor's operation range is restricted. Consult the technical service manual for more detailed information.
- Certification in process.

Dimensions and hydraulic connections

Outdoor unit - AU

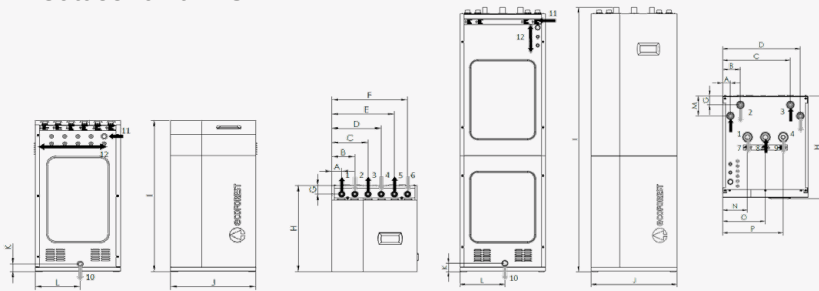

MODEL	DIMENSIONS (mm)															
	A	B	C	D	E	F	G	H	I	J	K	L	M	N	O	P
ecoGEO+ Basic	63	148	233	318	403	488	60	602	1058	550	53	290	-	-	-	-
ecoGEO+ Compact	55	125	475	545	-	-	62	720	1851	600	58	315	140	175	300	425

1. Heating/Cooling Outlet - 1" M
2. Heating/Cooling Inlet - 1" M
3. Brine Outlet - 1" M
4. Brine Inlet - 1" M
5. DHW System Outlet - 1" M
6. DHW System Inlet - 1" M
7. DCW Inlet - 1" F
8. DHW Outlet - 1" F
9. DHW Recirculation Inlet - 3/4" F
10. Drain - 16 mm

Operational chart

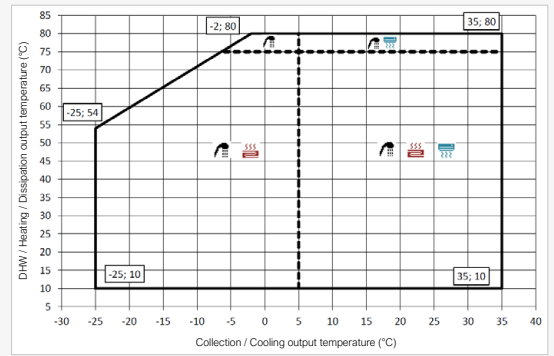

Installation management

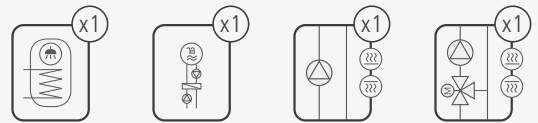

Performance curves

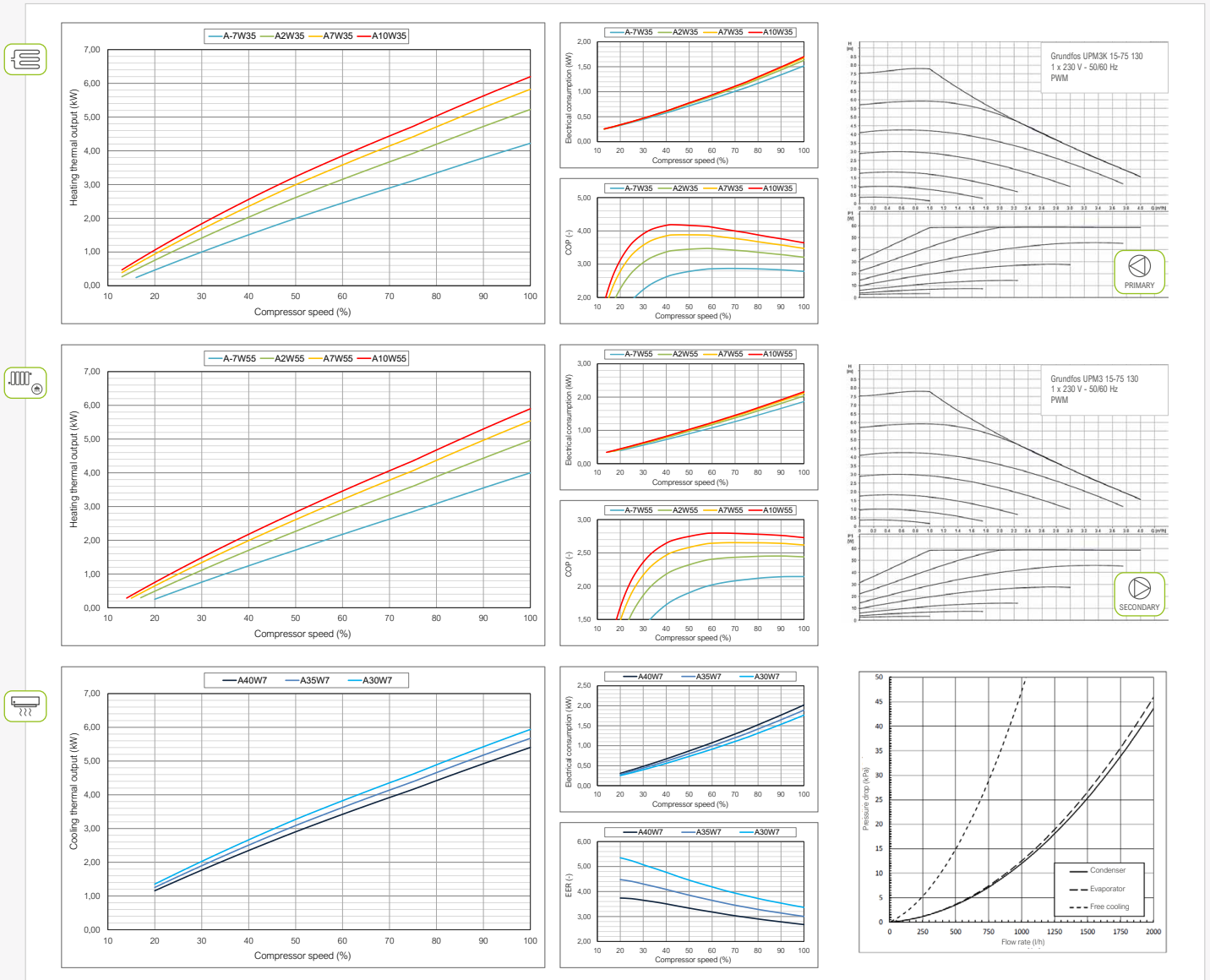

ecoGEO+ B/C 1-9 & AU12

- Modulating thermal power control within a wide range (20-100%) and modulating flow rate control of both brine and production circuits (20-100%).
- Inverter technology and scroll compressor.
- Compact design including brine and production circulation pumps, brine and production expansion vessels (8l and 12l respectively), brine and production safety valves and DHW three-way valve.
- High Temperature Recovery system (HTR) for DHW production up to 70 °C without electrical support and simultaneous production of DHW and heating/cooling.
- Integrated management of up to 3 different emission temperatures, 2 buffer tanks (heating and cooling), 1 DHW tank, 1 pool and hourly control of DHW recirculation.
- Integrated management of aerothermal collection modulating units, in case of air source or hybrid configurations.
- Integrated management of external On/Off or modulating auxiliary systems, such as electrical heaters, On/Off boilers or modulating boilers.
- Integrated management of cascade systems up to 3 units.
- Exclusive defrosting system.
- Integrated active cooling in models 4.
- Single-phase and Three-phase versions available.
- Integrated photovoltaic hybridisation.
- Integrated energy meters to measure the electrical consumption, the heating/cooling thermal power, the COP and the monthly and annual SPF.

SPECIFICATIONS ecoGEO+ B/C 1-9 & AU12		UNITS	B2/C2	B4/C4
APPLICATION	Place of installation	-	Indoors: ecoGEO+ 1-9 · Outdoors: AU12	
	Type of brine system ¹	-	Air source / Hybrid source	
	DHW, Heating and Pool	-	✓	✓
	High Temperature Recovery (HTR) system option	-	✓	✓ by default
	Integrated Active cooling	-	-	✓
PERFORMANCE	Integrated ecoGEO+ defrosting system	-	✓	✓
	Modulation range of the compressor	%	20 to 100	
	Heating power output ² , A7W35	kW	1,3 to 11,0	
	COP ² , A7W35	-	5,0	
	Active cooling power output ² , A35W7	kW	-	1,8 to 8,7
	EER ² , A35W7	-	-	2,9
	Max. DHW temperature without / with support ⁵	°C	63 / 70	
	Noise power emission level ⁶	db	33 to 44	
	Energy label / rjs / SCOP W35 average climate control	-	A+++ / 182% / 4,63	
	Energy label / rjs / SCOP W55 average climate control	-	A++ / 143% / 3,65	
OPERATION LIMITS	Distribution / Set heating outlet temperature range	°C	10 to 60 / 20 to 60	
	Distribution / Set cooling outlet temperature range	°C	4 to 35 / 7 to 25	
	Brine inlet temperature range in heating applications	°C	-25 to 35	
	Brine inlet temperature range in cooling applications	°C	10 to 60	
	Minimum / Maximum refrigerant circuit pressure	bar	2 / 45	
	Production / Pre-load circuit pressure	bar	0,5 to 3,0 / 1,5	
	Brine / Pre-load circuit pressure	bar	0,5 to 3,0 / 0,7	
	Volume / Max. DHW storage tank pressure (ecoGEO+ C)	l / bar	165 / 8	
WORKING FLUIDS	R410A Refrigerant load without HTR / with HTR	kg	0,75 / 0,85	1,0
	Compressor oil type / load	kg	POE / 0,74	
CONTROL ELECTRICAL DATA	1/N/PE 230 V / 50-60 Hz ⁸	-	✓	
	Maximum recommended external protection ⁹	-	C10A	
	Transformer primary circuit fuse	A	0,5	
ELECTRICAL DATA: SINGLE-PHASE	Transformer secondary circuit fuse	A	2,5	
	1/N/PE 230 V / 50-60 Hz ⁸	-	✓	
	Maximum recommended external protection ⁹	-	C25A	
	Maximum consumption ² , A7W35	kW / A	2,7 / 11,8	
	Maximum consumption ² , A7W55	kW / A	3,8 / 16,5	
	Minimum / Maximum starting current ⁷	A	2,8 / 5,8	
ELECTRICAL DATA: THREE-PHASE	Correction of cosine Ø	-	0,96/1	
	3/N/PE 400 V / 50-60Hz ⁸	-	✓	
	Maximum recommended external protection ⁹	-	C10A	
	Maximum consumption ² , A7W35	kW / A	2,7 / 4,0	
	Maximum consumption ² , A7W55	kW / A	3,8 / 5,5	
	Minimum / Maximum starting current ⁷	A	0,9 / 1,9	
DIMENSIONS/WEIGHT	Correction of cosine Ø	-	0,96/1	
	Height x width x depth	mm	ecoGEO+ B: 1060x600x710 · ecoGEO+ C: 1804x600x720 / AU12: 900x1000x600	
	Empty weight (without assembly)	kg	ecoGEO+ B: 192 · ecoGEO+ C: 253 / AU12: 92	

- Air source/Hybrid source by replacing/combining the ground source circuit by/with one or more ecoGEO+ AU. Consult the ecoGEO+ AU manual for more detailed information.
- In compliance with EN 14511, this includes the consumption of the circulation pumps and the compressor driver.
- Considering brine and production flow rates in compliance with EN 14511.
- Considering a heat slope from 20°C to 50°C in absence of consumption.
- Considering support provided by the emergency electrical heater or the HTR system. Maximum DHW temperature with the HTR system can be limited by the compressor discharge temperature.
- In compliance with EN 12102, this includes the acoustic insulation kit of the compressor.
- Starting current depends on the working conditions of the hydraulic circuits.
- The admissible voltage range for proper operation of the heat pump is ±10%.
- Maximum consumption can vary significantly according to working conditions, or if the compressor's operation range is restricted. Consult the technical service manual for more detailed information.
- Certification in process.

Dimensions and hydraulic connections

Outdoor unit - AU

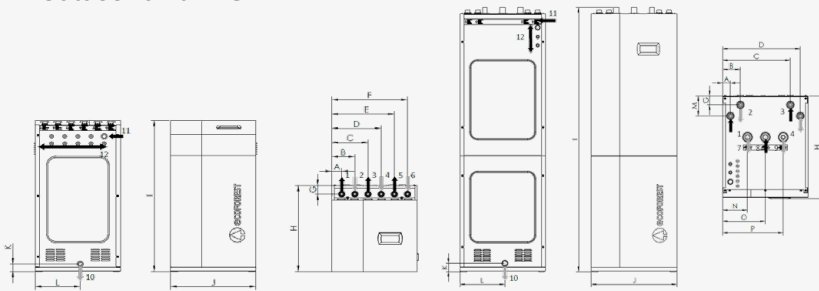

MODEL	DIMENSIONS (mm)															
	A	B	C	D	E	F	G	H	I	J	K	L	M	N	O	P
ecoGEO+ Basic	55	153	251	349	447	545	70	710	1058	600	61	300	-	-	-	-
ecoGEO+ Compact	55	125	475	545	-	-	62	720	1851	600	58	315	140	175	300	425

1. Heating/Cooling Outlet - 1 1/4" M
2. Heating/Cooling Inlet - 1 1/4" M
3. Brine Outlet - 1 1/4" M
4. Brine Inlet - 1 1/4" M
5. DHW System Outlet - 1 1/4" M
6. DHW System Inlet - 1 1/4" M
7. DCW Inlet - 1" F
8. DHW Outlet - 1" F
9. DHW Recirculation Inlet - 3/4" F
10. Drain - 16 mm

Operational chart

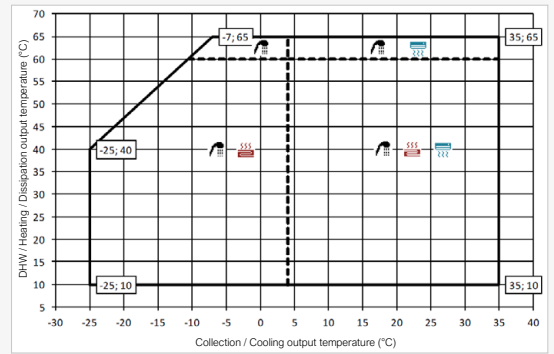

Installation management

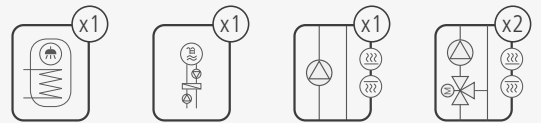

Performance curves

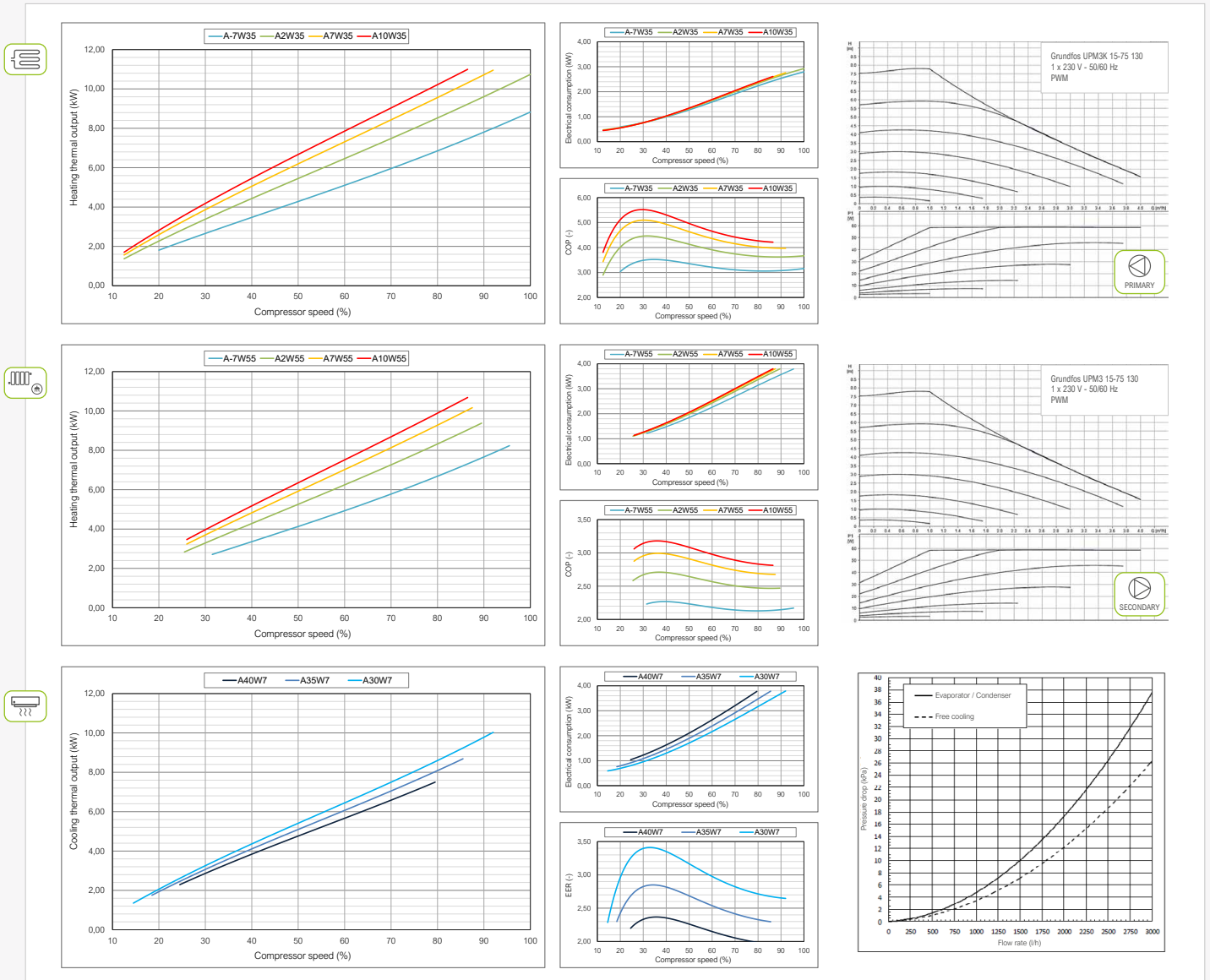

ecoGEO+ B/C 3-12 & AU12

- Modulating thermal power control within a wide range (20-100%) and modulating flow rate control of both brine and production circuits (20-100%).
- Inverter technology and scroll compressor.
- Compact design including brine and production circulation pumps, brine and production expansion vessels (8l and 12l respectively), brine and production safety valves and DHW three-way valve.
- High Temperature Recovery system (HTR) for DHW production up to 70 °C without electrical support and simultaneous production of DHW and heating/cooling.
- Integrated management of up to 3 different emission temperatures, 2 buffer tanks (heating and cooling), 1 DHW tank, 1 pool and hourly control of DHW recirculation.
- Integrated management of aérothermal collection modulating units, in case of air source or hybrid configurations.
- Integrated management of external On/Off or modulating auxiliary systems, such as electrical heaters, On/Off boilers or modulating boilers.
- Integrated management of cascade systems up to 3 units.
- Exclusive defrosting system.
- Integrated active cooling in models 4.
- Single-phase and Three-phase versions available.
- Integrated photovoltaic hybridisation.
- Integrated energy meters to measure the electrical consumption, the heating/cooling thermal power, the COP and the monthly and annual SPF.

SPECIFICATIONS ecoGEO+ B/C 3-12 & AU12		UNITS	B2/C2	B4/C4
APPLICATION	Place of installation	-	Indoors: ecoGEO+ 3-12 · Outdoors: AU12	
	Type of brine system ¹	-	Air source / Hybrid source	
	DHW, Heating and Pool	-	✓	✓
	High Temperature Recovery (HTR) system option	-	✓	✓ by default
	Integrated Active cooling	-	-	✓
PERFORMANCE	Integrated ecoGEO+ defrosting system	-	✓	✓
	Modulation range of the compressor	%	20 to 100	
	Heating power output ² , A7W35	kW	2,3 to 14,6	
	COP ² , A7W35	-	4,9	
	Active cooling power output ² , A35W7	kW	-	2,4 to 11,4
	EER ² , A35W7	-	-	3,4
	Max. DHW temperature without / with support ⁵	°C	63 / 70	
	Noise power emission level ⁶	db	34 to 45	
	Energy label / rjs / SCOP W35 average climate control	-	A+++ / 190% / 4,83	
	Energy label / rjs / SCOP W55 average climate control	-	A++ / 143% / 3,64	
OPERATION LIMITS	Distribution / Set heating outlet temperature range	°C	10 to 60 / 20 to 60	
	Distribution / Set cooling outlet temperature range	°C	4 to 35 / 7 to 25	
	Brine inlet temperature range in heating applications	°C	-25 to 35	
	Brine inlet temperature range in cooling applications	°C	10 to 60	
	Minimum / Maximum refrigerant circuit pressure	bar	2 / 45	
	Production / Pre-load circuit pressure	bar	0,5 to 3,0 / 1,5	
	Brine / Pre-load circuit pressure	bar	0,5 to 3,0 / 0,7	
	Volume / Max. DHW storage tank pressure (ecoGEO+ C)	l / bar	165 / 8	
WORKING FLUIDS	R410A Refrigerant load without HTR / with HTR	kg	0,9 / 1,0	1,0
	Compressor oil type / load	kg	POE / 0,74	
CONTROL ELECTRICAL DATA	1/N/PE 230 V / 50-60 Hz ⁸	-	✓	
	Maximum recommended external protection ⁹	-	C16A	
	Transformer primary circuit fuse	A	0,5	
ELECTRICAL DATA: SINGLE-PHASE	Transformer secondary circuit fuse	A	2,5	
	1/N/PE 230 V / 50-60 Hz ⁸	-	✓	
	Maximum recommended external protection ⁹	-	C32A	
	Maximum consumption ² , A7W35	kW / A	4,2 / 18,6	
	Maximum consumption ² , A7W55	kW / A	5,0 / 21,7	
	Minimum / Maximum starting current ⁷	A	2,0 / 8,0	
ELECTRICAL DATA: THREE-PHASE	Correction of cosine Ø	-	0,96/1	
	3/N/PE 400 V / 50-60Hz ⁸	-	✓	
	Maximum recommended external protection ⁹	-	C16A	
	Maximum consumption ² , A7W35	kW / A	4,2 / 6,2	
	Maximum consumption ² , A7W55	kW / A	5,0 / 7,2	
	Minimum / Maximum starting current ⁷	A	0,7 / 2,6	
DIMENSIONS/WEIGHT	Correction of cosine Ø	-	0,96/1	
	Height x width x depth	mm	ecoGEO+ B: 1060x600x710 · ecoGEO+ C: 1804x600x720 / AU12: 900x1000x600	
	Empty weight (without assembly)	kg	ecoGEO+ B: 193 · ecoGEO+ C: 254 / AU12: 92	

- Air source/Hybrid source by replacing/combining the ground source circuit by/with one or more ecoGEO+ AU. Consult the ecoGEO+ AU manual for more detailed information.
- In compliance with EN 14511, this includes the consumption of the circulation pumps and the compressor driver.
- Considering brine and production flow rates in compliance with EN 14511.
- Considering a heat slope from 20°C to 50°C in absence of consumption.
- Considering support provided by the emergency electrical heater or the HTR system. Maximum DHW temperature with the HTR system can be limited by the compressor discharge temperature.
- In compliance with EN 12102, this includes the acoustic insulation kit of the compressor.
- Starting current depends on the working conditions of the hydraulic circuits.
- The admissible voltage range for proper operation of the heat pump is ±10%.
- Maximum consumption can vary significantly according to working conditions, or if the compressor's operation range is restricted. Consult the technical service manual for more detailed information.
- Certification in process.

Dimensions and hydraulic connections

Outdoor unit - AU

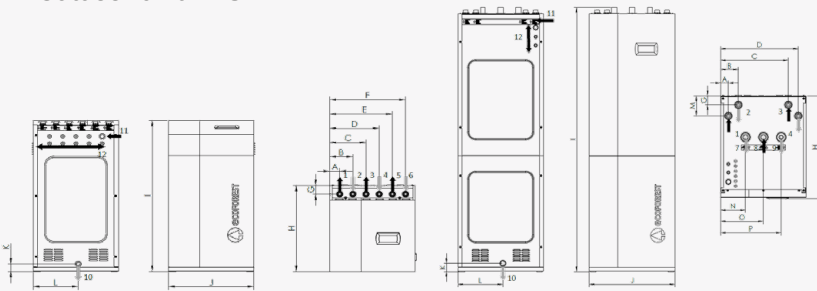

MODEL	DIMENSIONS (mm)															
	A	B	C	D	E	F	G	H	I	J	K	L	M	N	O	P
ecoGEO+ Basic	55	153	251	349	447	545	70	710	1058	600	61	300	-	-	-	-
ecoGEO+ Compact	55	125	475	545	-	-	62	720	1851	600	58	315	140	175	300	425

1. Heating/Cooling Outlet - 1 1/4" M
2. Heating/Cooling Inlet - 1 1/4" M
3. Brine Outlet - 1 1/4" M
4. Brine Inlet - 1 1/4" M
5. DHW System Outlet - 1 1/4" M
6. DHW System Inlet - 1 1/4" M
7. DCW Inlet - 1" F
8. DHW Outlet - 1" F
9. DHW Recirculation Inlet - 3/4" F
10. Drain - 16 mm

Operational chart

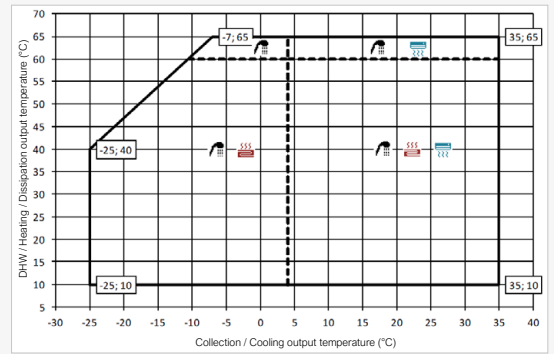

Installation management

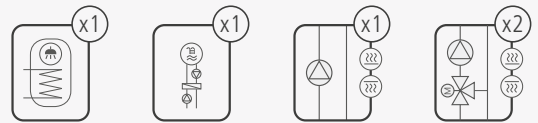

Performance curves

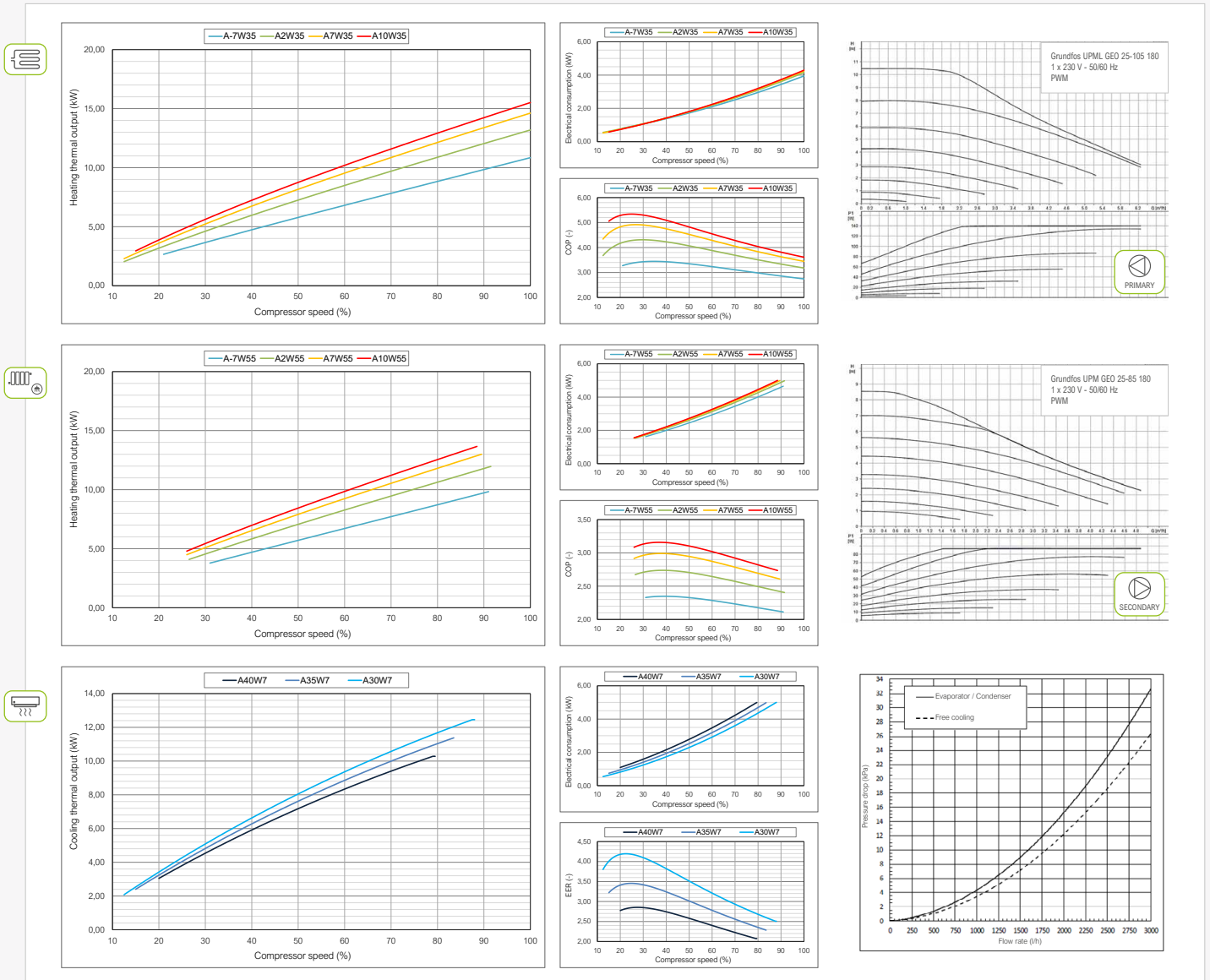

ecoGEO+ B/C 5-22 & AU12

- Modulating thermal power control within a wide range (20-100%) and modulating flow rate control of both brine and production circuits (20-100%).
- Inverter technology and scroll compressor.
- Compact design including brine and production circulation pumps, brine and production expansion vessels (8l and 12l respectively), brine and production safety valves and DHW three-way valve.
- High Temperature Recovery system (HTR) for DHW production up to 70 °C without electrical support and simultaneous production of DHW and heating/cooling.
- Integrated management of up to 3 different emission temperatures, 2 buffer tanks (heating and cooling), 1 DHW tank, 1 pool and hourly control of DHW recirculation.
- Integrated management of aerothermal collection modulating units, in case of air source or hybrid configurations.
- Integrated management of external On/Off or modulating auxiliary systems, such as electrical heaters, On/Off boilers or modulating boilers.
- Integrated management of cascade systems up to 3 units.
- Exclusive defrosting system.
- Integrated active cooling in models 4.
- Single-phase and Three-phase versions available.
- Integrated photovoltaic hybridisation.
- Integrated energy meters to measure the electrical consumption, the heating/cooling thermal power, the COP and the monthly and annual SPF.

SPECIFICATIONS ecoGEO+ B/C 5-22 & AU12		UNITS	B2/C2	B4/C4
APPLICATION	Place of installation	-	Indoors: ecoGEO+ 5-22 · Outdoors: AU12	
	Type of brine system ¹	-	Air source / Hybrid source	
	DHW, Heating and Pool	-	✓	✓
	High Temperature Recovery (HTR) system option	-	✓	✓ by default
	Integrated Active cooling	-	-	✓
PERFORMANCE	Integrated ecoGEO+ defrosting system	-	✓	✓
	Modulation range of the compressor	%	20 to 100	
	Heating power output ² , A7W35	kW	3,6 to 19,4	
	COP ² , A7W35	-	4,9	
	Active cooling power output ² , A35W7	kW	-	4,1 to 13,4
	EER ² , A35W7	-	-	3,1
	Max. DHW temperature without / with support ⁵	°C	63 / 70	
	Noise power emission level ⁶	db	35 to 46	
	Energy label / rjs / SCOP W35 average climate control	-	A+++ / 198% / 5,03	
	Energy label / rjs / SCOP W55 average climate control	-	A++ / 143% / 3,66	
OPERATION LIMITS	Distribution / Set heating outlet temperature range	°C	10 to 60 / 20 to 60	
	Distribution / Set cooling outlet temperature range	°C	4 to 35 / 7 to 25	
	Brine inlet temperature range in heating applications	°C	-25 to 35	
	Brine inlet temperature range in cooling applications	°C	10 to 60	
	Minimum / Maximum refrigerant circuit pressure	bar	2 / 45	
	Production / Pre-load circuit pressure	bar	0,5 to 3,0 / 1,5	
	Brine / Pre-load circuit pressure	bar	0,5 to 3,0 / 0,7	
	Volume / Max. DHW storage tank pressure (ecoGEO+ C)	l / bar	165 / 8	
WORKING FLUIDS	R410A Refrigerant load without HTR / with HTR	kg	1,4	1,5
	Compressor oil type / load	kg	POE / 1,18	
CONTROL ELECTRICAL DATA	1/N/PE 230 V / 50-60 Hz ⁸	-	✓	
	Maximum recommended external protection ⁹	-	C16A	
	Transformer primary circuit fuse	A	0,5	
ELECTRICAL DATA: SINGLE-PHASE	Transformer secondary circuit fuse	A	2,5	
	1/N/PE 230 V / 50-60 Hz ⁸	-	✓	
	Maximum recommended external protection ⁹	-	C32A	
	Maximum consumption ² , A7W35	kW / A	5,5 / 23,9	
	Maximum consumption ² , A7W55	kW / A	5,5 / 23,9	
	Minimum / Maximum starting current ⁷	A	2,6 / 12,5	
ELECTRICAL DATA: THREE-PHASE	Correction of cosine Ø	-	0,96/1	
	3/N/PE 400 V / 50-60Hz ⁸	-	✓	
	Maximum recommended external protection ⁹	-	C13A	
	Maximum consumption ² , A7W35	kW / A	6,0 / 8,7	
	Maximum consumption ² , A7W55	kW / A	6,0 / 8,7	
	Minimum / Maximum starting current ⁷	A	0,9 / 4,2	
DIMENSIONS/WEIGHT	Correction of cosine Ø	-	0,96/1	
	Height x width x depth	mm	ecoGEO+ B: 1060x600x710 · ecoGEO+ C: 1804x600x720 / AU12: 900x1000x600	
	Empty weight (without assembly)	kg	ecoGEO+ B: 193 · ecoGEO+ C: 255 / AU12: 92	

- Air source/Hybrid source by replacing/combining the ground source circuit by/with one or more ecoGEO+ AU. Consult the ecoGEO+ AU manual for more detailed information.
- In compliance with EN 14511, this includes the consumption of the circulation pumps and the compressor driver.
- Considering brine and production flow rates in compliance with EN 14511.
- Considering a heat slope from 20°C to 50°C in absence of consumption.
- Considering support provided by the emergency electrical heater or the HTR system. Maximum DHW temperature with the HTR system can be limited by the compressor discharge temperature.
- In compliance with EN 12102, this includes the acoustic insulation kit of the compressor.
- Starting current depends on the working conditions of the hydraulic circuits.
- The admissible voltage range for proper operation of the heat pump is ±10%.
- Maximum consumption can vary significantly according to working conditions, or if the compressor's operation range is restricted. Consult the technical service manual for more detailed information.
- Certification in process.

Dimensions and hydraulic connections

Outdoor unit - AU

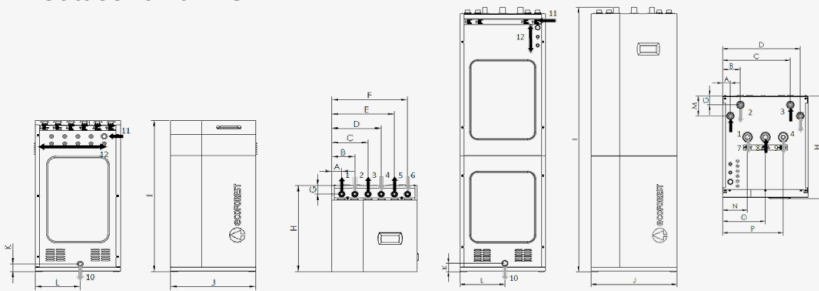

MODEL	DIMENSIONS (mm)															
	A	B	C	D	E	F	G	H	I	J	K	L	M	N	O	P
ecoGEO+ Basic	55	153	251	349	447	545	70	710	1058	600	61	300	-	-	-	-
ecoGEO+ Compact	55	125	475	545	-	-	62	720	1851	600	58	315	140	175	300	425

1. Heating/Cooling Outlet - 1 1/4" M
2. Heating/Cooling Inlet - 1 1/4" M
3. Brine Outlet - 1 1/4" M
4. Brine Inlet - 1 1/4" M
5. DHW System Outlet - 1 1/4" M
6. DHW System Inlet - 1 1/4" M
7. DCW Inlet - 1" F
8. DHW Outlet - 1" F
9. DHW Recirculation Inlet - 3/4" F
10. Drain - 16 mm

Operational chart

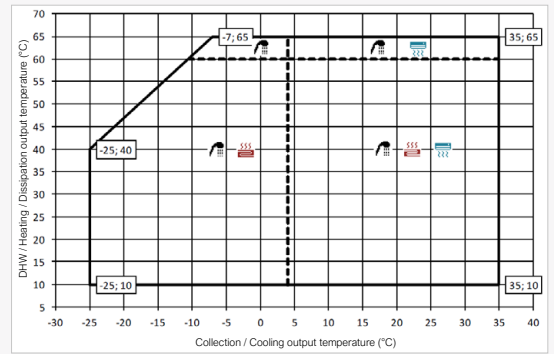

Installation management

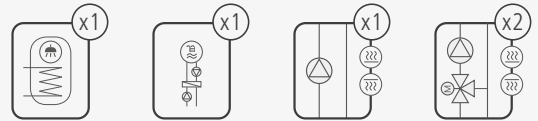

Performance curves

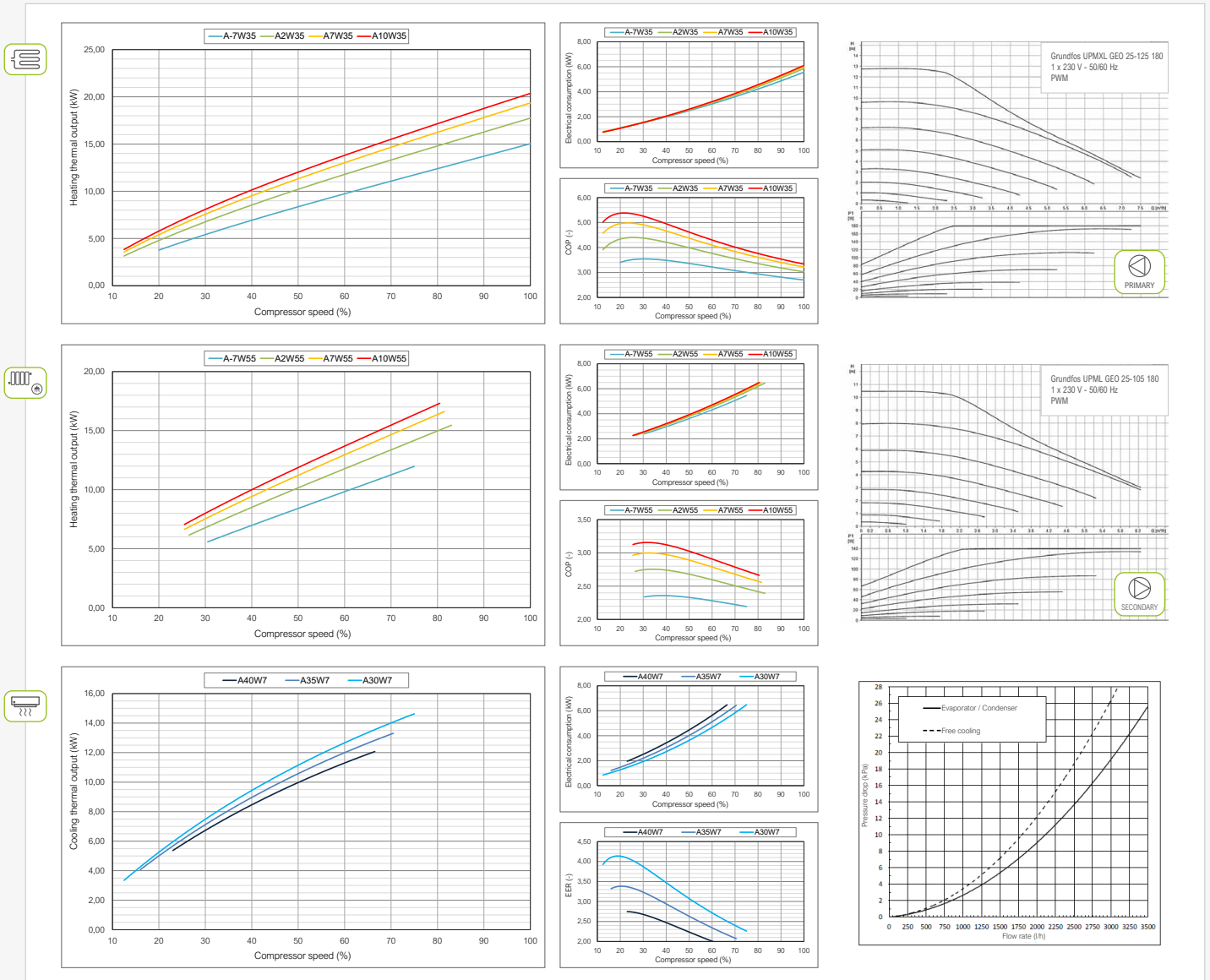

ecoGEO+ B/C 5-22 & AU22

- Modulating thermal power control within a wide range (20-100%) and modulating flow rate control of both brine and production circuits (20-100%).
- Inverter technology and scroll compressor.
- Compact design including brine and production circulation pumps, brine and production expansion vessels (8l and 12l respectively), brine and production safety valves and DHW three-way valve.
- High Temperature Recovery system (HTR) for DHW production up to 70 °C without electrical support and simultaneous production of DHW and heating/cooling.
- Integrated management of up to 3 different emission temperatures, 2 buffer tanks (heating and cooling), 1 DHW tank, 1 pool and hourly control of DHW recirculation.
- Integrated management of aerothermal collection modulating units, in case of air source or hybrid configurations.
- Integrated management of external On/Off or modulating auxiliary systems, such as electrical heaters, On/Off boilers or modulating boilers.
- Integrated management of cascade systems up to 3 units.
- Exclusive defrosting system.
- Integrated active cooling in models 4.
- Single-phase and Three-phase versions available.
- Integrated photovoltaic hybridisation.
- Integrated energy meters to measure the electrical consumption, the heating/cooling thermal power, the COP and the monthly and annual SPF.

SPECIFICATIONS ecoGEO+ B/C 5-22 & AU22		UNITS	B2/C2	B4/C4
APPLICATION	Place of installation	-	Indoors: ecoGEO+ 5-22 · Outdoors: AU22	
	Type of brine system ¹	-	Air source / Hybrid source	
	DHW, Heating and Pool	-	✓	✓
	High Temperature Recovery (HTR) system option	-	✓	✓ by default
	Integrated Active cooling	-	-	✓
PERFORMANCE	Integrated ecoGEO+ defrosting system	-	✓	✓
	Modulation range of the compressor	%	20 to 100	
	Heating power output ² , A7W35	kW	3,7 to 22,2	
	COP ² , A7W35	-	5,2	
	Active cooling power output ² , A35W7	kW	-	4,6 to 16,2
	EER ² , A35W7	-	-	3,8
	Max. DHW temperature without / with support ⁵	°C	63 / 70	
	Noise power emission level ⁶	db	35 to 46	
	Energy label / rjs / SCOP W35 average climate control	-	A+++ / 198% / 5,03	
	Energy label / rjs / SCOP W55 average climate control	-	A++ / 143% / 3,66	
OPERATION LIMITS	Distribution / Set heating outlet temperature range	°C	10 to 60 / 20 to 60	
	Distribution / Set cooling outlet temperature range	°C	4 to 35 / 7 to 25	
	Brine inlet temperature range in heating applications	°C	-25 to 35	
	Brine inlet temperature range in cooling applications	°C	10 to 60	
	Minimum / Maximum refrigerant circuit pressure	bar	2 / 45	
	Production / Pre-load circuit pressure	bar	0,5 to 3,0 / 1,5	
	Brine / Pre-load circuit pressure	bar	0,5 to 3,0 / 0,7	
	Volume / Max. DHW storage tank pressure (ecoGEO+ C)	l / bar	165 / 8	
WORKING FLUIDS	R410A Refrigerant load without HTR / with HTR	kg	1,4	1,5
	Compressor oil type / load	kg	POE / 1,18	
CONTROL ELECTRICAL DATA	1/N/PE 230 V / 50-60 Hz ⁸	-	✓	
	Maximum recommended external protection ⁹	-	C16A	
	Transformer primary circuit fuse	A	0,5	
ELECTRICAL DATA: SINGLE-PHASE	Transformer secondary circuit fuse	A	2,5	
	1/N/PE 230 V / 50-60 Hz ⁸	-	✓	
	Maximum recommended external protection ⁹	-	C32A	
	Maximum consumption ² , A7W35	kW / A	5,5 / 23,9	
	Maximum consumption ² , A7W55	kW / A	5,5 / 23,9	
	Minimum / Maximum starting current ⁷	A	2,6 / 12,5	
ELECTRICAL DATA: THREE-PHASE	Correction of cosine Ø	-	0,96/1	
	3/N/PE 400 V / 50-60Hz ⁸	-	✓	
	Maximum recommended external protection ⁹	-	C13A	
	Maximum consumption ² , A7W35	kW / A	6,0 / 8,7	
	Maximum consumption ² , A7W55	kW / A	6,0 / 8,7	
	Minimum / Maximum starting current ⁷	A	0,9 / 4,2	
DIMENSIONS/WEIGHT	Correction of cosine Ø	-	0,96/1	
	Height x width x depth	mm	ecoGEO+ B: 1060x600x710 · ecoGEO+ C: 1804x600x720 / AU22: 900x1800x600	
	Empty weight (without assembly)	kg	ecoGEO+ B: 193 · ecoGEO+ C: 255 / AU22: 175	

- Air source/Hybrid source by replacing/combining the ground source circuit by/with one or more ecoGEO+ AU. Consult the ecoGEO+ AU manual for more detailed information.
- In compliance with EN 14511, this includes the consumption of the circulation pumps and the compressor driver.
- Considering brine and production flow rates in compliance with EN 14511.
- Considering a heat slope from 20°C to 50°C in absence of consumption.
- Considering support provided by the emergency electrical heater or the HTR system. Maximum DHW temperature with the HTR system can be limited by the compressor discharge temperature.
- In compliance with EN 12102, this includes the acoustic insulation kit of the compressor.
- Starting current depends on the working conditions of the hydraulic circuits.
- The admissible voltage range for proper operation of the heat pump is ±10%.
- Maximum consumption can vary significantly according to working conditions, or if the compressor's operation range is restricted. Consult the technical service manual for more detailed information.
- Certification in process.

Dimensions and hydraulic connections

Outdoor unit - AU

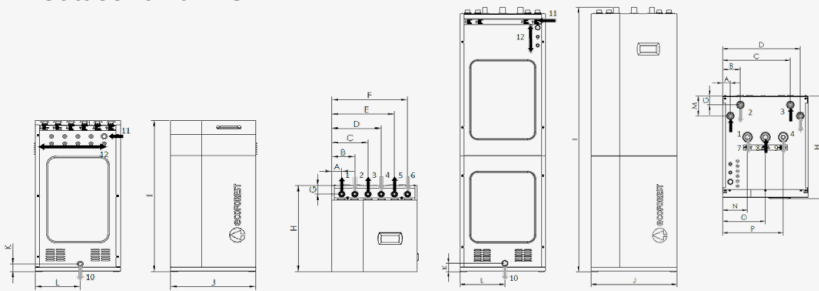

MODEL	DIMENSIONS (mm)															
	A	B	C	D	E	F	G	H	I	J	K	L	M	N	O	P
ecoGEO+ Basic	55	153	251	349	447	545	70	710	1058	600	61	300	-	-	-	-
ecoGEO+ Compact	55	125	475	545	-	-	62	720	1851	600	58	315	140	175	300	425

1. Heating/Cooling Outlet - 1 1/4" M
2. Heating/Cooling Inlet - 1 1/4" M
3. Brine Outlet - 1 1/4" M
4. Brine Inlet - 1 1/4" M
5. DHW System Outlet - 1 1/4" M
6. DHW System Inlet - 1 1/4" M
7. DCW Inlet - 1" F
8. DHW Outlet - 1" F
9. DHW Recirculation Inlet - 3/4" F
10. Drain - 16 mm

Operational chart

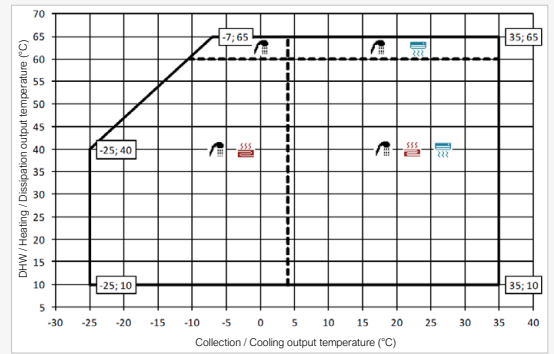

Installation management

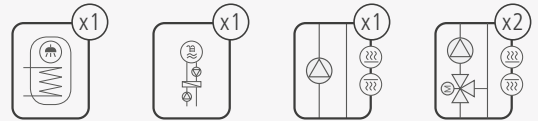

Performance curves

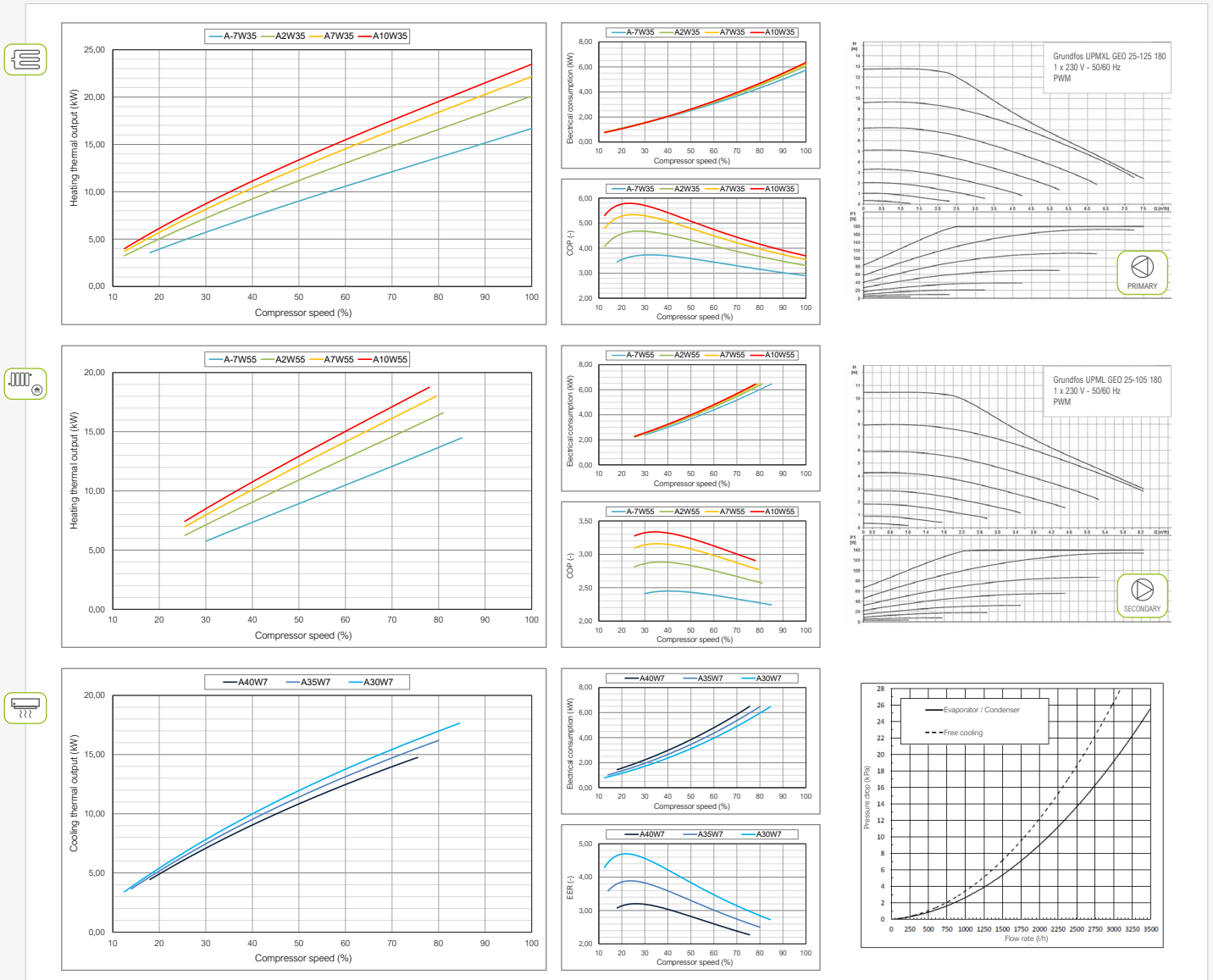

ecoAIR⁺

Monobloc air source heat pumps



ecoAIR⁺

Monobloc Inverter air source

The ecoAIR⁺ range is the Ecoforest range of air-to-water heat pumps. These heat pumps use Inverter technology and are also capable of offering all the services required in a HVAC system in an integrated way: DHW, Heating, Pool and Cooling.



All ecoAIR⁺ heat pumps make use of Inverter technology, which allows them to modulate their power in order to adapt to the thermal demands of the installation with the highest efficiency. This translates into a very considerable reduction in electrical consumption and great savings. The ecoAIR⁺ EVI heat pumps make a unique use of EVI technology to guarantee unique performances in any operating condition, and the ecoAIR⁺ PRO heat pumps use a natural refrigerant, being the only propane monobloc aerothermal heat pumps that have modulation ranges greater than 80%. Thanks to the technology and control strategies developed by Ecoforest, the installation of ecoAIR⁺ heat pumps in combination with the HK and HK-Compact indoor units also becomes simpler, more compact and cheaper than those of other heat pumps on the market, since it allows to dispense with certain components that would be necessary in traditional heat pump installations.

ecoAIR+ PRO

Residential range



Power ranges

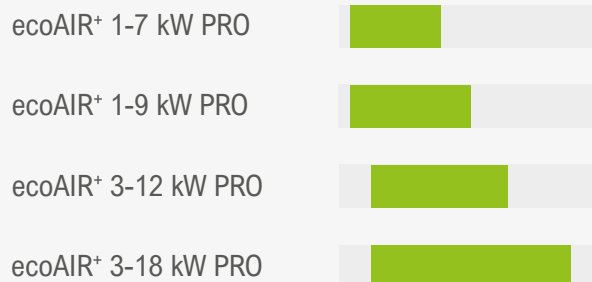

Monobloc heat pump

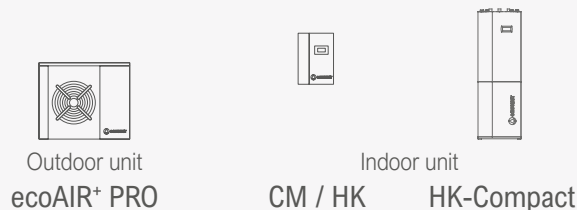

Services



DHW



Heating



Cooling



Pool

Indoor units

CM

Controller
Display

HK-EH

Controller
Display
Filling kit & filter
DHW 3-way valve
Support electrical heater

HK-EH-S

Controller
Display
Filling kit & filter
DHW 3-way valve
Support electrical heater
Heat exchanger & circulation pump

HK-Compact-EH

Controller
Display
Filling kit & filter
DHW 3-way valve
Support electrical heater
165l stainless steel DHW tank

HK-Compact-EH-S

Controller
Display
Filling kit & filter
DHW 3-way valve
Support electrical heater
Heat exchanger & circulation pump
165l stainless steel DHW tankde
Expansion vessel & safety valve



- Inverter technology
- Power ranges: 1-7 kW / 1-9 kW / 3-12 kW / 3-18 kW
- Natural refrigerant: R290
- Hot water production temperatures up to 75°C
- Domestic hot water production
- Heating and pool production
- Integrated active cooling production
- Modulating speed fan
- Internet connection through the ecoSMART Easynet
- Integrated photovoltaic hybridisation
- Single-phase (230V) or three-phase (400V) power supply

Unique performances

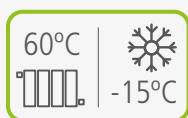

DHW production and Heating

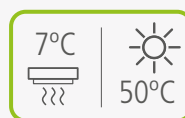

Cooling

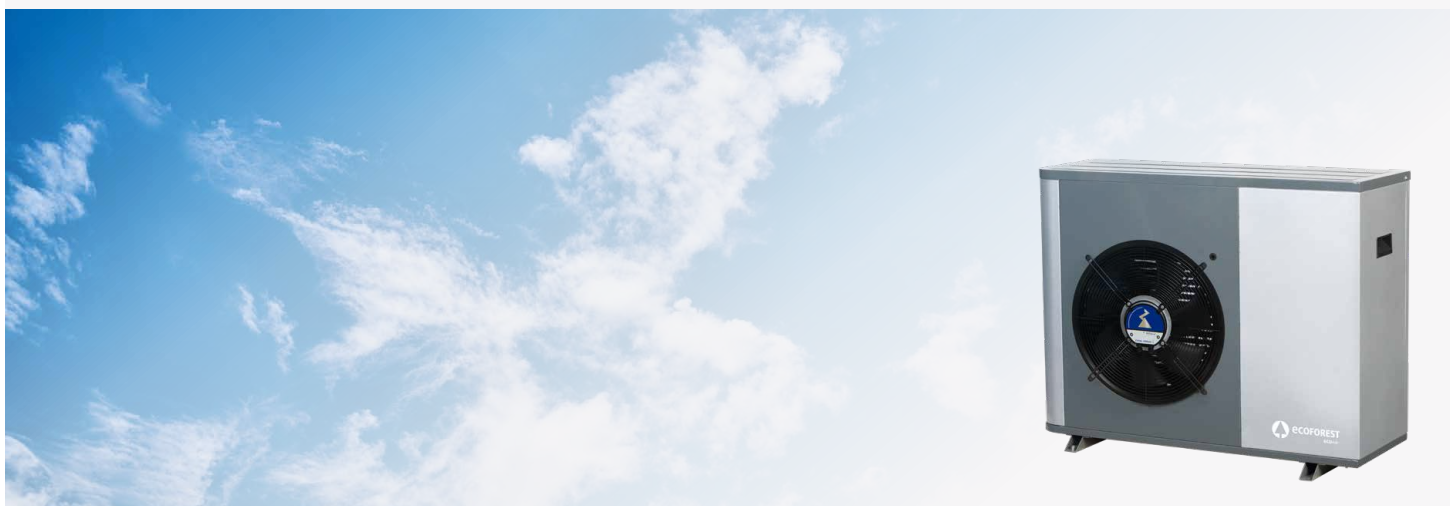

Indoor units

CM / HK / HK-Compact

- Indoor hydraulic units to be used in combination with ecoAIR⁺ PRO monobloc aérothermal heat pumps.
- CM, HK & HK-Compact: including the electrical box that allows to control the heat pump.
- HK & HK-Compact: including the main hydraulic components of the installation in several combinations.
- HK-Compact: integrating a 165l stainless steel DHW tank.
- Plug&play compact units that make the hydraulic system simpler and the installation easier.
- Single-phase control electrical box.
- Single-phase or Three-phase optional support electrical heater.

SPECIFICATIONS ecoAIR ⁺ PRO INDOOR UNITS		UNITS	CM	HK		HK-Compact	
				HK-EH	HK-EH-S	HK-Compact-EH	HK-Compact-EH-S
APPLICATION	Place of installation	-		Indoors			
	DHW	-	✓	✓	✓	✓	✓
	Heating and Pool	-	✓	✓	✓	✓	✓
	Cooling	-	✓	✓	✓	✓	✓
INTEGRATED HYRAULIC COMPONENTS	Filling kit and filter	-	-	✓	✓	✓	✓
	DHW three-way valve	-	-	✓	✓	✓	✓
	Support electrical heater	-	-	✓	✓	✓	✓
	Separation plate heat exchanger	-	-	-	✓	-	✓
	Secondary circuit circulation pump	-	-	-	✓	-	✓
	Stainless steel DHW tank	-	-	-	-	✓	✓
	Primary / Secondary expansion vessel	-	-	-	-	✓(12l)	✓(8l) / ✓(12l)
OPERATION LIMITS	Production circuit pressure	bar	-				
	DHW tank volume	l	-	-	-	165	
	DHW tank maximum pressure	bar	-	-	-	8,0	
	DHW tank maximum temperature	°C	-	-	-	80	
CONTROL ELECTRICAL DATA	1/N/PE 230 V / 50-60 Hz ¹	-			✓		
	Recommended external protection	-			C5A		
	Transformer primary circuit fuse	A			0,5		
	Transformer secondary circuit fuse	A			2,5		
ELECTRICAL DATA: INTEGRATED SUPPORT ELECTRICAL HEATER	Supply: 1/N/PE 230Vac / 50-60 Hz ¹	-	-			✓	
	Número de elementos	-	-			1 ² / 1-2-3	
	Recommended external protection 1-2-3	-	-			C16A ² / C10A-C16A-C20A	
	Maximum power consumption 1-2-3	kW	-			2,0 ² / 1,3-2,7-4,0	
	Maximum current consumption 1-2-3	A	-			10,0 ² / 6,3-12,6-18,9	
	Supply: 3/N/PE 400Vac / 50-60 Hz ¹	-	-			✓	
	Recommended external protection	-	-			C10A	
	Maximum power consumption	kW	-			4,0	
Maximum current consumption	A	-			6,3		
Correction of cosine Ø	-	-			0,96/1		
DIMENSIONS/WEIGHT	Height x width x depth	mm	600x400x158			1770x595x678	
	Empty weight (without assembly)	kg	15	40 ² / 44	43 ² / 47	130	145

1. The admissible voltage range for proper operation of the heat pump is ±10%.
2. Data to be considered in case of HK-EH or HK-Compact-EH for ecoAIR⁺ 1-7kW PRO models.

Dimensions and hydraulic connections

Indoor unit - CM / HK / HK-Compact

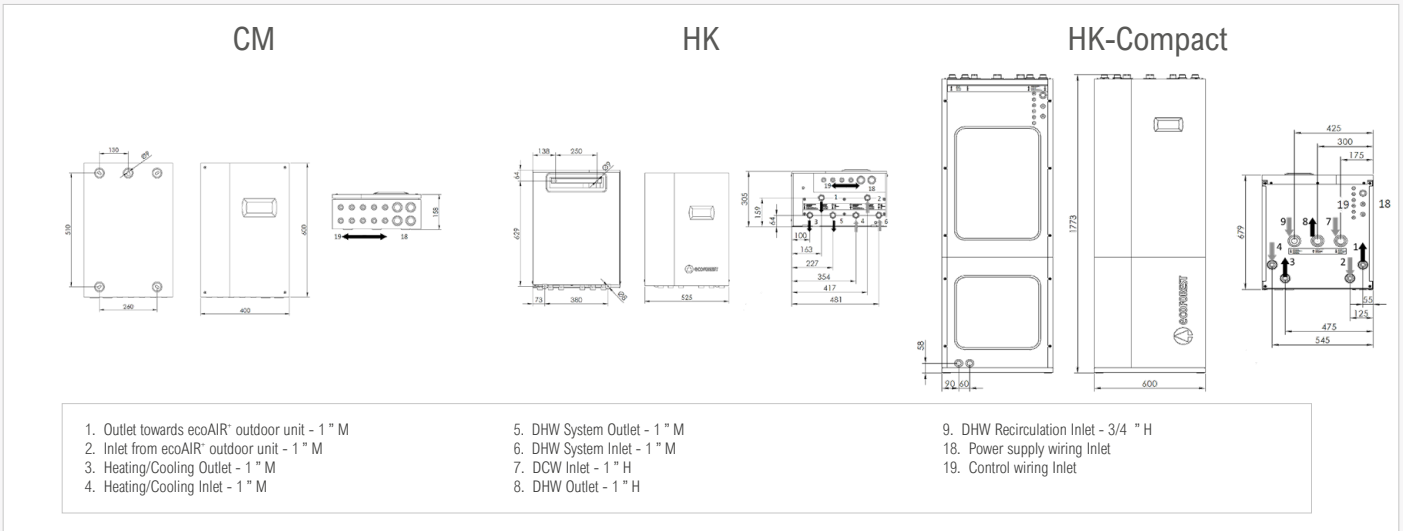

Hydraulic characteristics

Hydraulic layouts

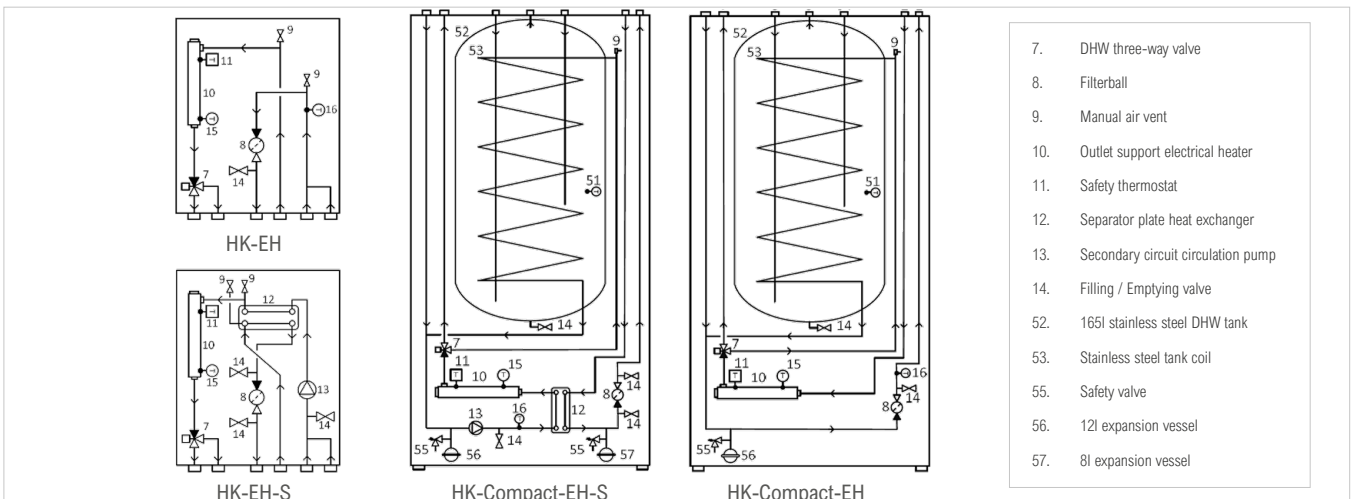

Models including hydraulic separation : HK-EH-S / HK-Compact-EH-S

Separation plate heat exchanger
Thermal power

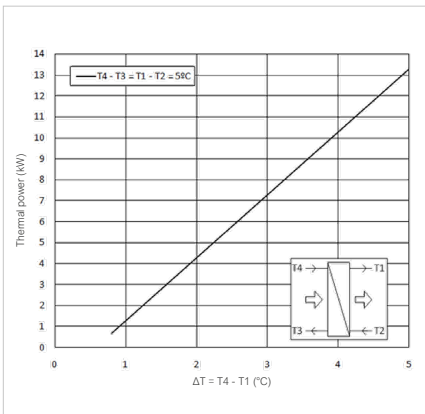

Separation plate heat exchanger
Pressure drop

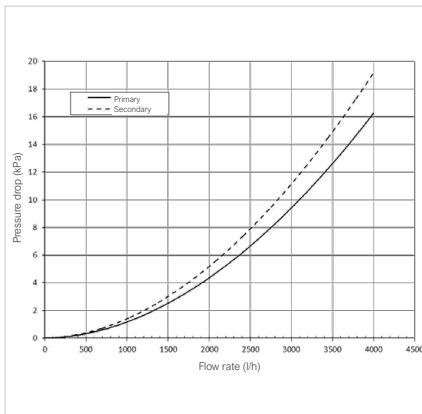

Secondary circuit circulation pump
Pressure drop, thermal power and flow rate

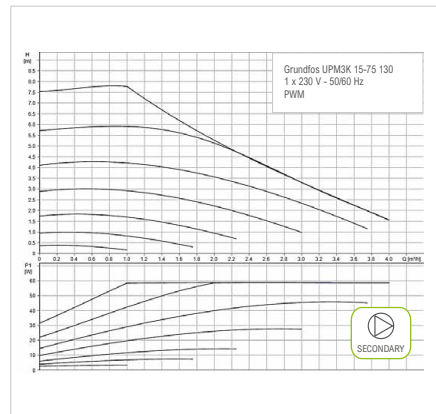

ecoAIR⁺ 1-7 PRO



- Modulating thermal power control within a wide range (17-100%) and modulating flow rate control of the production circuit (20-100%).
- Natural refrigerant R290 : GWP 3.
- Inverter technology and scroll compressor.
- Compact design including the production circulation pump in the outdoor unit. Hydraulic connection within the outdoor unit and the indoor unit.
- Integrated management of up to 3 different emission temperatures, 2 buffer tanks (heating and cooling), 1 DHW tank, 1 pool and hourly control of DHW recirculation.
- Integrated management of simultaneous heating/cooling emission, according to scheme.
- Integrated management of external On/Off or modulating auxiliary systems, such as electrical heaters, On/Off boilers or modulating boilers.
- Integrated active cooling.
- Selection of the indoor unit depending on the installation needs.
- Single-phase version available.
- Integrated photovoltaic hybridisation.
- Integrated energy meters to measure the electrical consumption, the heating/cooling thermal power, the COP and the monthly and annual SPF.

SPECIFICATIONS ecoAIR ⁺ 1-7 PRO		UNITS	
APPLICATION	Place of installation	-	Outdoors
	Type of brine system ¹	-	Air source
	DHW, Heating and Pool	-	✓
	Integrated Active cooling	-	✓
PERFORMANCE	Modulation range of the compressor	%	15 to 100
	Heating power output ^{2, 10} , A7W35	kW	1,0 to 7,0
	COP ^{2, 10} , A7W35	-	5,2
	Heating power output ^{2, 10} , A7W55	kW	1,0 to 6,5
	COP ^{2, 10} , A7W55	-	3,3
	Active cooling power output ^{2, 10} , A35W7	kW	1,0 to 5,6
	EER ^{2, 10} , A35W7	-	5,5
	Max. DHW temperature without / with support ⁵	°C	75 / 80
	Noise power emission level ^{6, 10}	db	55
	Energy label / rjs / SCOP W35 average climate control	-	A+++ / 179% / 4,57
Energy label / rjs / SCOP W55 average climate control	-	A++ / 139% / 3,58	
OPERATION LIMITS	Distribution / Set heating outlet temperature range	°C	10 to 75 / 20 to 75
	Distribution / Set cooling outlet temperature range	°C	5 to 30 / 7 to 30
	Outdoor temperature range	°C	-22 to 50
	Minimum / Maximum refrigerant circuit pressure	bar	0,5 / 31,5
	Production circuit pressure	bar	0,5 to 3,0
WORKING FLUIDS	R290 Refrigerant load	kg	0,75
	Compressor oil type / load	kg	PZ46M / 0,3
CONTROL ELECTRICAL DATA	1/N/PE 230 V / 50-60 Hz ⁸	-	✓
	Maximum recommended external protection ⁹	-	C5A
	Transformer primary circuit fuse	A	0,5
	Transformer secondary circuit fuse	A	2,5
ELECTRICAL DATA: SINGLE-PHASE	1/N/PE 230 V / 50-60 Hz ⁸	-	✓
	Maximum recommended external protection ⁹	-	C25A
	Maximum consumption ² , A7W35	kW / A	1,5 / 7,6
	Maximum consumption ² , A7W55	kW / A	2,0 / 9,8
	Minimum / Maximum starting current ⁷	A	1,1 / 1,3
	Correction of cosine Ø	-	0,96/1
DIMENSIONS/WEIGHT	Height x width x depth	mm	823x1040x435
	Empty weight (without assembly)	kg	115

1. Outdoor air-to-water monobloc unit.

2. In compliance with EN 14511, this includes the consumption of the circulation pumps and the compressor driver.

3. Considering brine and production flow rates in compliance with EN 14511.

4. Considering a heat slope from 20°C to 50°C in absence of consumption.

5. Considering support provided by the emergency electrical heater or the HTR system. Maximum DHW temperature with the HTR system can be limited by the compressor discharge temperature.

6. In compliance with EN 12102, this includes the acoustic insulation kit of the compressor.

7. Starting current depends on the working conditions of the hydraulic circuits.

8. The admissible voltage range for proper operation of the heat pump is ±10%.

9. Maximum consumption can vary significantly according to working conditions, or if the compressor's operation range is restricted. Consult the technical service manual for more detailed information.

10. Certification in process.

Dimensions and hydraulic connections

Outdoor unit - ecoAIR+

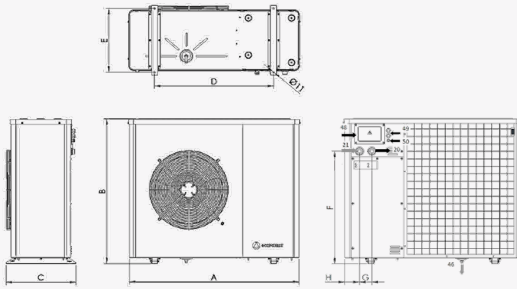

MODEL	DIMENSIONS (mm)							
	A	B	C	D	E	F	G	H
ecoAIR+ 1-7 PRO	1050	823	435	760	390	606	80	108

- 20. Heating/Cooling Outlet - 1" M
- 21. Heating/Cooling Inlet - 1" M
- 46. Drain - 15 mm
- 48. Electrical connections box
- 49. Power supply wiring Inlet
- 50. Control wiring Inlet

Operational chart

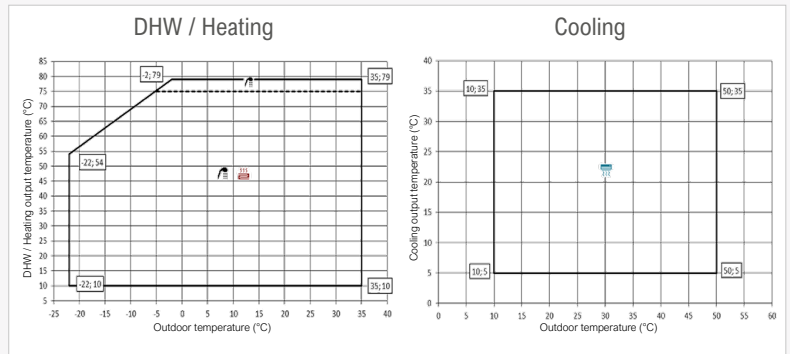

Installation management

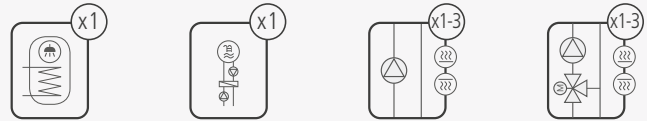

Performance curves

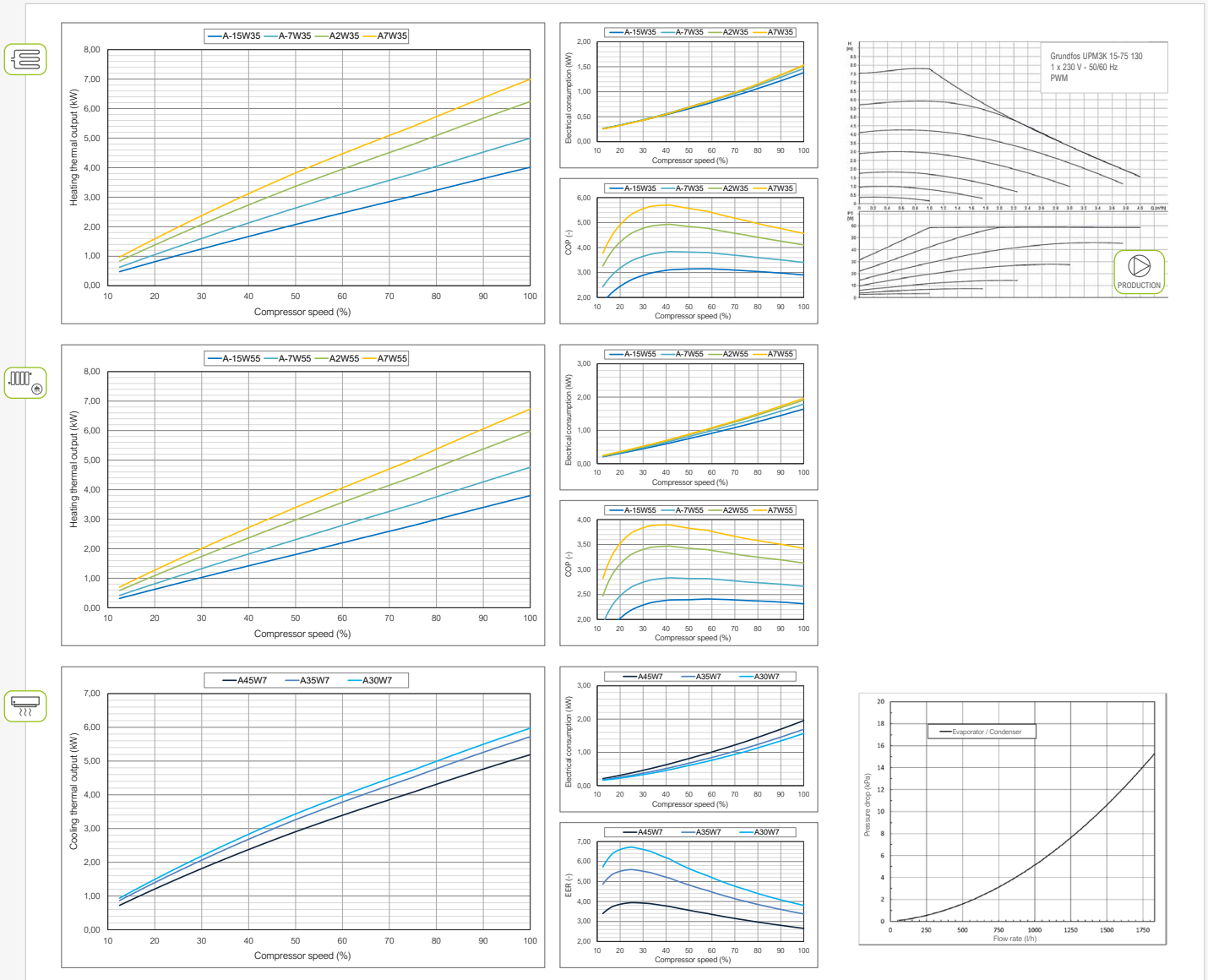

ecoAIR⁺ 1-9 PRO



- Modulating thermal power control within a wide range (17-100%) and modulating flow rate control of the production circuit (20-100%).
- Natural refrigerant R290 : GWP 3.
- Inverter technology and scroll compressor.
- Compact design including the production circulation pump in the outdoor unit. Hydraulic connection within the outdoor unit and the indoor unit.
- Integrated management of up to 3 different emission temperatures, 2 buffer tanks (heating and cooling), 1 DHW tank, 1 pool and hourly control of DHW recirculation.
- Integrated management of simultaneous heating/cooling emission, according to scheme.
- Integrated management of external On/Off or modulating auxiliary systems, such as electrical heaters, On/Off boilers or modulating boilers.
- Integrated active cooling.
- Selection of the indoor unit depending on the installation needs.
- Single-phase version available.
- Integrated photovoltaic hybridisation.
- Integrated energy meters to measure the electrical consumption, the heating/cooling thermal power, the COP and the monthly and annual SPF.

SPECIFICATIONS ecoAIR ⁺ 1-9 PRO		UNITS	
APPLICATION	Place of installation	-	Outdoors
	Type of brine system ¹	-	Air source
	DHW, Heating and Pool	-	✓
	Integrated Active cooling	-	✓
PERFORMANCE	Modulation range of the compressor	%	17 to 100
	Heating power output ^{2, 10} , A7W35	kW	1,7 to 8,7
	COP ^{2, 10} , A7W35	-	5,0
	Heating power output ^{2, 10} , A7W55	kW	2,1 to 8,0
	COP ^{2, 10} , A7W55	-	3,2
	Active cooling power output ^{2, 10} , A35W7	kW	1,1 to 7,1
	EER ^{2, 10} , A35W7	-	4,0
	Max. DHW temperature without / with support ⁵	°C	70 / 80
	Noise power emission level ^{6, 10}	db	57
	Energy label / rjs / SCOP W35 average climate control	-	A+++ / 180% / 4,58
Energy label / rjs / SCOP W55 average climate control	-	A++ / 142% / 3,63	
OPERATION LIMITS	Distribution / Set heating outlet temperature range	°C	10 to 70 / 20 to 70
	Distribution / Set cooling outlet temperature range	°C	5 to 30 / 7 to 30
	Outdoor temperature range	°C	-22 to 50
	Minimum / Maximum refrigerant circuit pressure	bar	0,5 / 27,5
	Production circuit pressure	bar	0,5 to 3,0
WORKING FLUIDS	R290 Refrigerant load	kg	0,85
	Compressor oil type / load	kg	PZ46M / 0,74
CONTROL ELECTRICAL DATA	1/N/PE 230 V / 50-60 Hz ⁸	-	✓
	Maximum recommended external protection ⁹	-	C5A
	Transformer primary circuit fuse	A	0,5
	Transformer secondary circuit fuse	A	2,5
ELECTRICAL DATA: SINGLE-PHASE	1/N/PE 230 V / 50-60 Hz ⁸	-	✓
	Maximum recommended external protection ⁹	-	C25A
	Maximum consumption ² , A7W35	kW / A	1,9 / 9,5
	Maximum consumption ² , A7W55	kW / A	2,6 / 13,0
	Minimum / Maximum starting current ⁷	A	3,3 / 4,4
DIMENSIONS/WEIGHT	Correction of cosine Ø	-	0,97/1
	Height x width x depth	mm	971x1140x475
	Empty weight (without assembly)	kg	134

1. Outdoor air-to-water monobloc unit.

2. In compliance with EN 14511, this includes the consumption of the circulation pumps and the compressor driver.

3. Considering brine and production flow rates in compliance with EN 14511.

4. Considering a heat slope from 20°C to 50°C in absence of consumption.

5. Considering support provided by the emergency electrical heater or the HTR system. Maximum DHW temperature with the HTR system can be limited by the compressor discharge temperature.

6. In compliance with EN 12102, this includes the acoustic insulation kit of the compressor.

7. Starting current depends on the working conditions of the hydraulic circuits.

8. The admissible voltage range for proper operation of the heat pump is ±10%.

9. Maximum consumption can vary significantly according to working conditions, or if the compressor's operation range is restricted. Consult the technical service manual for more detailed information.

10. Certification in process.

Dimensions and hydraulic connections

Outdoor unit - ecoAIR+

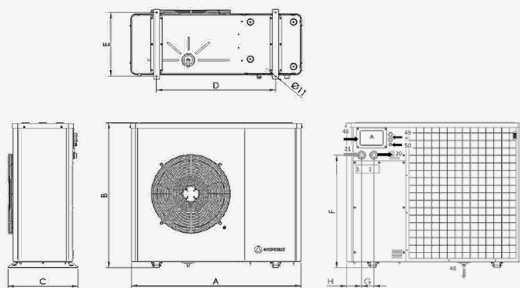

MODEL	DIMENSIONS (mm)							
	A	B	C	D	E	F	G	H
ecoAIR+ 1-9 PRO	1150	973	475	800	430	750	80	100

- 20. Heating/Cooling Outlet - 1" M
- 21. Heating/Cooling Inlet - 1" M
- 46. Drain - 15 mm
- 48. Electrical connections box
- 49. Power supply wiring Inlet
- 50. Control wiring Inlet

Operational chart

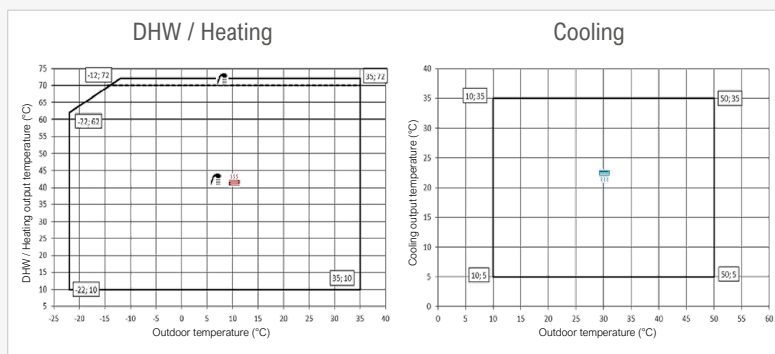

Installation management

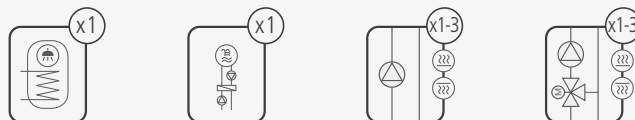

Performance curves

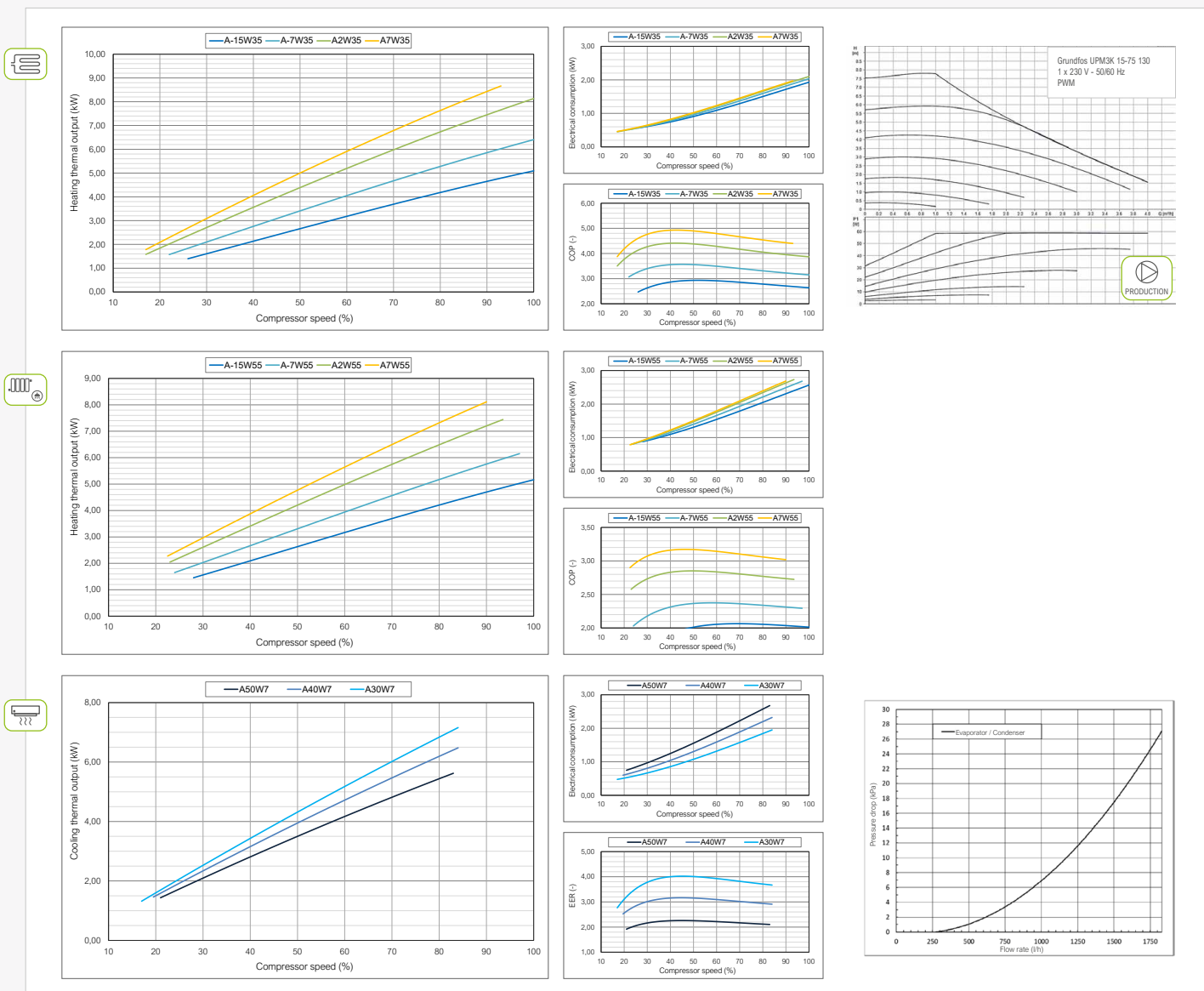

ecoAIR⁺ 3-12 PRO



- Modulating thermal power control within a wide range (17-100%) and modulating flow rate control of the production circuit (20-100%).
- Natural refrigerant R290 : GWP 3.
- Inverter technology and scroll compressor.
- Compact design including the production circulation pump in the outdoor unit. Hydraulic connection within the outdoor unit and the indoor unit.
- Integrated management of up to 3 different emission temperatures, 2 buffer tanks (heating and cooling), 1 DHW tank, 1 pool and hourly control of DHW recirculation.
- Integrated management of simultaneous heating/cooling emission, according to scheme.
- Integrated management of external On/Off or modulating auxiliary systems, such as electrical heaters, On/Off boilers or modulating boilers.
- Integrated active cooling.
- Selection of the indoor unit depending on the installation needs.
- Single-phase and Three-phase versions available.
- Integrated photovoltaic hybridisation.
- Integrated energy meters to measure the electrical consumption, the heating/cooling thermal power, the COP and the monthly and annual SPF.

SPECIFICATIONS ecoAIR ⁺ 3-12 PRO		UNITS	
APPLICATION	Place of installation	-	Outdoors
	Type of brine system ¹	-	Air source
	DHW, Heating and Pool	-	✓
	Integrated Active cooling	-	✓
PERFORMANCE	Modulation range of the compressor	%	17 to 100
	Heating power output ^{2, 10} , A7W35	kW	3,0 to 11,0
	COP ^{2, 10} , A7W35	-	4,8
	Heating power output ^{2, 10} , A7W55	kW	3,0 to 10,0
	COP ^{2, 10} , A7W55	-	3,0
	Active cooling power output ^{2, 10} , A35W7	kW	1,8 to 9,0
	EER ^{2, 10} , A35W7	-	3,7
	Max. DHW temperature without / with support ⁵	°C	70 / 80
	Noise power emission level ^{6, 10}	db	55
	Energy label / rjs / SCOP W35 average climate control	-	A+++ / 158% / 4,10
Energy label / rjs / SCOP W55 average climate control	-	A++ / 129% / 3,33	
OPERATION LIMITS	Distribution / Set heating outlet temperature range	°C	10 to 70 / 20 to 70
	Distribution / Set cooling outlet temperature range	°C	5 to 30 / 7 to 30
	Outdoor temperature range	°C	-22 to 50
	Minimum / Maximum refrigerant circuit pressure	bar	0,5 / 27,5
	Production circuit pressure	bar	0,5 to 3,0
WORKING FLUIDS	R290 Refrigerant load	kg	0,85
	Compressor oil type / load	kg	HXL4467 / 0,74
CONTROL ELECTRICAL DATA	1/N/PE 230 V / 50-60 Hz ⁸	-	✓
	Maximum recommended external protection ⁹	-	C5A
	Transformer primary circuit fuse	A	0,5
	Transformer secondary circuit fuse	A	2,5
ELECTRICAL DATA: SINGLE-PHASE	1/N/PE 230 V / 50-60 Hz ⁸	-	✓
	Maximum recommended external protection ⁹	-	C25A
	Maximum consumption ² , B0W35	kW / A	2,8 / 13,8
	Consumo máximo ² , B0W55	kW / A	3,5 / 17,7
	Maximum consumption ² , B0W55	A	4,4 / 5,3
Correction of cosine Ø	-	0,93/1	
ELECTRICAL DATA: THREE-PHASE	3/N/PE 400 V / 50-60Hz ⁸	-	✓
	Maximum recommended external protection ⁹	-	C25A
	Maximum consumption ² , A7W35	kW / A	2,8 / 4,6
	Maximum consumption ² , A7W55	kW / A	3,5 / 5,9
	Minimum / Maximum starting current ⁷	A	1,5 / 1,8
Correction of cosine Ø	-	0,93/1	
DIMENSIONS/WEIGHT	Height x width x depth	mm	970x1140x475
	Empty weight (without assembly)	kg	134

1. Outdoor air-to-water monobloc unit.

2. In compliance with EN 14511, this includes the consumption of the circulation pumps and the compressor driver.

3. Considering brine and production flow rates in compliance with EN 14511.

4. Considering a heat slope from 20°C to 50°C in absence of consumption.

5. Considering support provided by the emergency electrical heater or the HTR system. Maximum DHW temperature with the HTR system can be limited by the compressor discharge temperature.

6. In compliance with EN 12102, this includes the acoustic insulation kit of the compressor.

7. Starting current depends on the working conditions of the hydraulic circuits.

8. The admissible voltage range for proper operation of the heat pump is ±10%.

9. Maximum consumption can vary significantly according to working conditions, or if the compressor's operation range is restricted. Consult the technical service manual for more detailed information.

10. Certification in process.

Dimensions and hydraulic connections

Outdoor unit - ecoAIR+

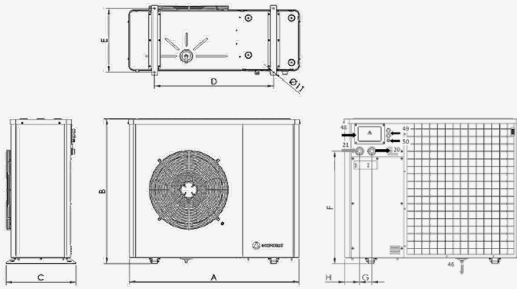

MODEL	DIMENSIONS (mm)							
	A	B	C	D	E	F	G	H
ecoAIR+ 3-12 PRO	1150	973	475	800	430	750	80	100

- 20. Heating/Cooling Outlet - 1" M
- 21. Heating/Cooling Inlet - 1" M
- 46. Drain - 15 mm
- 48. Electrical connections box
- 49. Power supply wiring Inlet
- 50. Control wiring Inlet

Operational chart

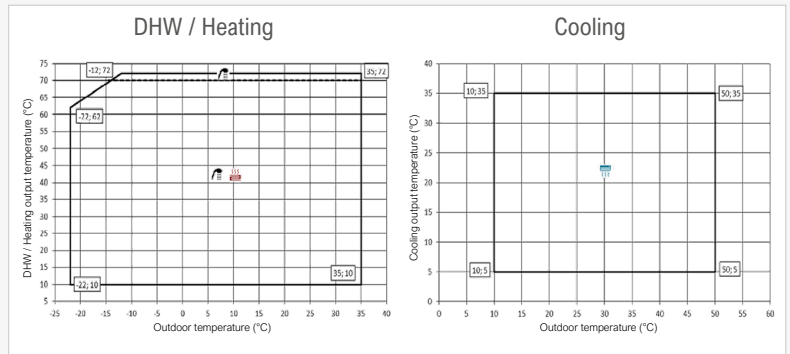

Installation management

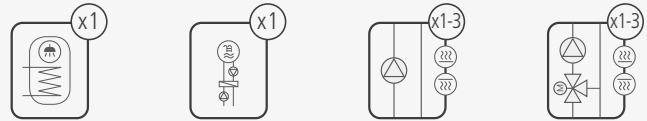

Performance curves

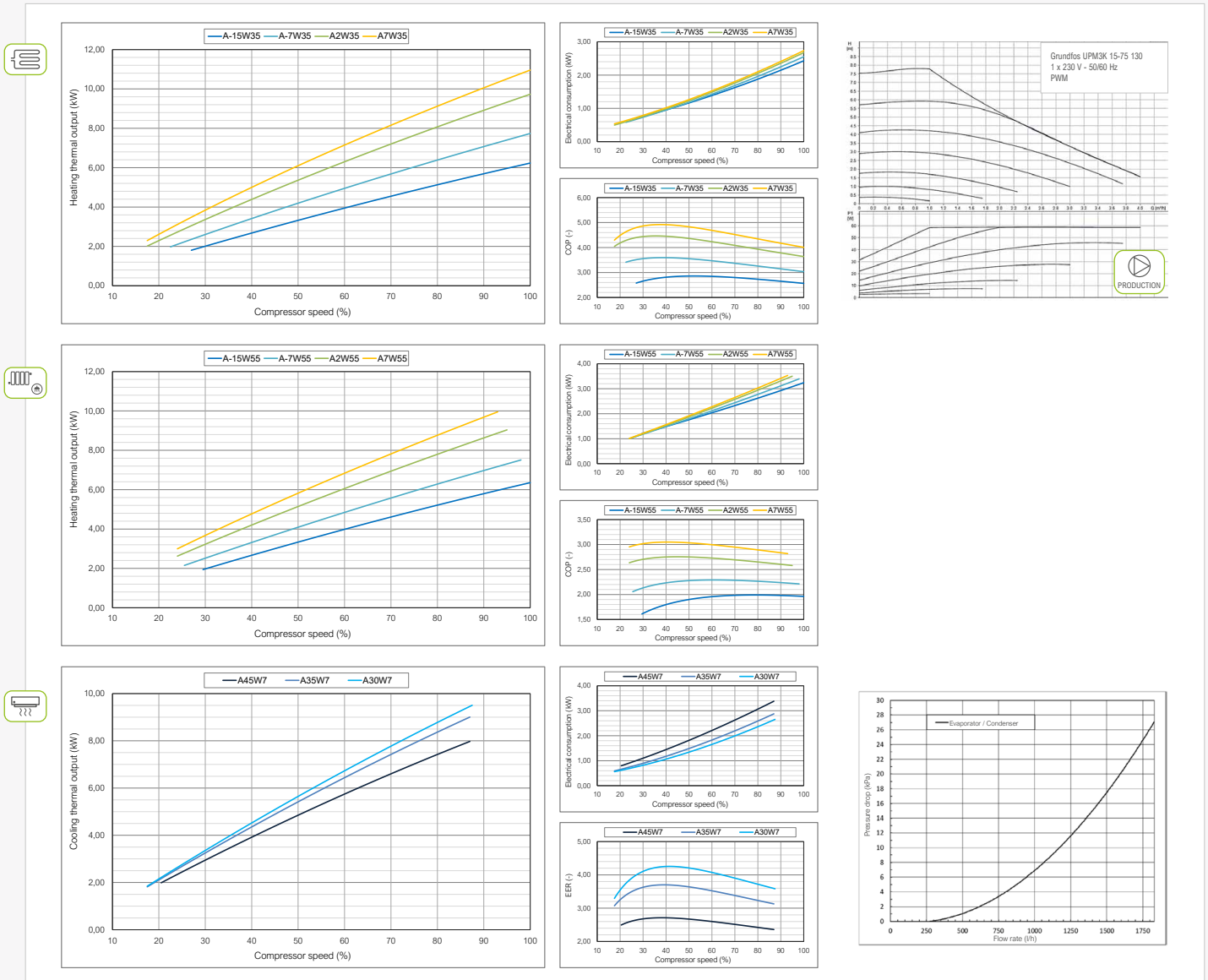

ecoAIR⁺ 3-18 PRO



- Modulating thermal power control within a wide range (17-100%) and modulating flow rate control of the production circuit (20-100%).
- Natural refrigerant R290 : GWP 3.
- Inverter technology and scroll compressor.
- Compact design including the production circulation pump in the outdoor unit. Hydraulic connection within the outdoor unit and the indoor unit.
- Integrated management of up to 3 different emission temperatures, 2 buffer tanks (heating and cooling), 1 DHW tank, 1 pool and hourly control of DHW recirculation.
- Integrated management of simultaneous heating/cooling emission, according to scheme.
- Integrated management of external On/Off or modulating auxiliary systems, such as electrical heaters, On/Off boilers or modulating boilers.
- Integrated active cooling.
- Selection of the indoor unit depending on the installation needs.
- Single-phase and Three-phase versions available.
- Integrated photovoltaic hybridisation.
- Integrated energy meters to measure the electrical consumption, the heating/cooling thermal power, the COP and the monthly and annual SPF.

SPECIFICATIONS ecoAIR ⁺ 3-18 PRO		UNITS	
APPLICATION	Place of installation	-	Outdoors
	Type of brine system ¹	-	Air source
	DHW, Heating and Pool	-	✓
	Integrated Active cooling	-	✓
PERFORMANCE	Modulation range of the compressor	%	17 to 100
	Heating power output ^{2, 10} , A7W35	kW	3,5 to 18,0
	COP ^{2, 10} , A7W35	-	5,1
	Heating power output ^{2, 10} , A7W55	kW	4,7 to 15,9
	COP ^{2, 10} , A7W55	-	3,35
	Active cooling power output ^{2, 10} , A35W7	kW	2,8 to 10,1
	EER ^{2, 10} , A35W7	-	3,79
	Max. DHW temperature without / with support ⁵	°C	70 / 80
	Noise power emission level ^{6, 10}	db	57
	Energy label / rjs / SCOP W35 average climate control	-	A+++ / 175% / 4,46
Energy label / rjs / SCOP W55 average climate control	-	A++ / 138% / 3,53	
OPERATION LIMITS	Distribution / Set heating outlet temperature range	°C	10 to 70 / 20 to 70
	Distribution / Set cooling outlet temperature range	°C	5 to 30 / 7 to 30
	Outdoor temperature range	°C	-22 to 50
	Minimum / Maximum refrigerant circuit pressure	bar	0,5 / 25,5
	Production circuit pressure	bar	0,5 to 3,0
WORKING FLUIDS	R290 Refrigerant load	kg	1,37
	Compressor oil type / load	kg	HXL4467 / 0,74
CONTROL ELECTRICAL DATA	1/N/PE 230 V / 50-60 Hz ⁸	-	✓
	Maximum recommended external protection ⁹	-	C5A
	Transformer primary circuit fuse	A	0,5
	Transformer secondary circuit fuse	A	2,5
ELECTRICAL DATA: SINGLE-PHASE	1/N/PE 230 V / 50-60 Hz ⁸	-	.. ¹⁰
	Maximum recommended external protection ⁹	-	.. ¹⁰
	Maximum consumption ² , B0W35	kW / A	.. ¹⁰
	Consumo máximo ² , B0W55	kW / A	.. ¹⁰
	Maximum consumption ² , B0W55	A	.. ¹⁰
ELECTRICAL DATA: THREE-PHASE	Correction of cosine Ø	-	.. ¹⁰
	3/N/PE 400 V / 50-60Hz ⁸	-	✓
	Maximum recommended external protection ⁹	-	C16A
	Maximum consumption ² , A7W35	kW / A	4,22 / 6,69
	Maximum consumption ² , A7W55	kW / A	5,36 / 8,47
DIMENSIONS/WEIGHT	Minimum / Maximum starting current ⁷	A	2,72 / 3,52
	Correction of cosine Ø	-	0,94 / 1
	Height x width x depth	mm	1250x1240x625
	Empty weight (without assembly)	kg	175

1. Outdoor air-to-water monobloc unit.

2. In compliance with EN 14511, this includes the consumption of the circulation pumps and the compressor driver.

3. Considering brine and production flow rates in compliance with EN 14511.

4. Considering a heat slope from 20°C to 50°C in absence of consumption.

5. Considering support provided by the emergency electrical heater or the HTR system. Maximum DHW temperature with the HTR system can be limited by the compressor discharge temperature.

6. In compliance with EN 12102, this includes the acoustic insulation kit of the compressor.

7. Starting current depends on the working conditions of the hydraulic circuits.

8. The admissible voltage range for proper operation of the heat pump is ±10%.

9. Maximum consumption can vary significantly according to working conditions, or if the compressor's operation range is restricted. Consult the technical service manual for more detailed information.

10. Certification in process.

Dimensions and hydraulic connections

Outdoor unit - ecoAIR+

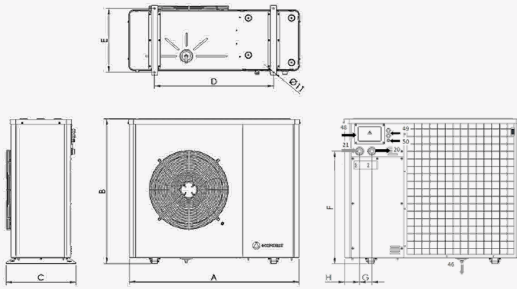

MODEL	DIMENSIONS (mm)							
	A	B	C	D	E	F	G	H
ecoAIR+ 3-18 PRO	1350	1254	625	800	580	975	80	105

- 20. Heating/Cooling Outlet - 1 1/4" M
- 21. Heating/Cooling Inlet - 1 1/4" M
- 46. Drain - 15 mm
- 48. Electrical connections box
- 49. Power supply wiring Inlet
- 50. Control wiring Inlet

Operational chart

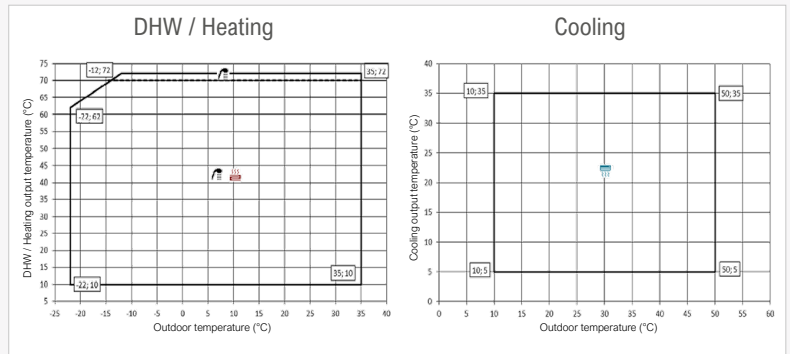

Installation management

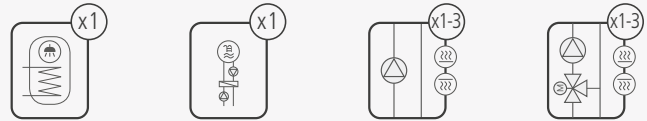

Performance curves

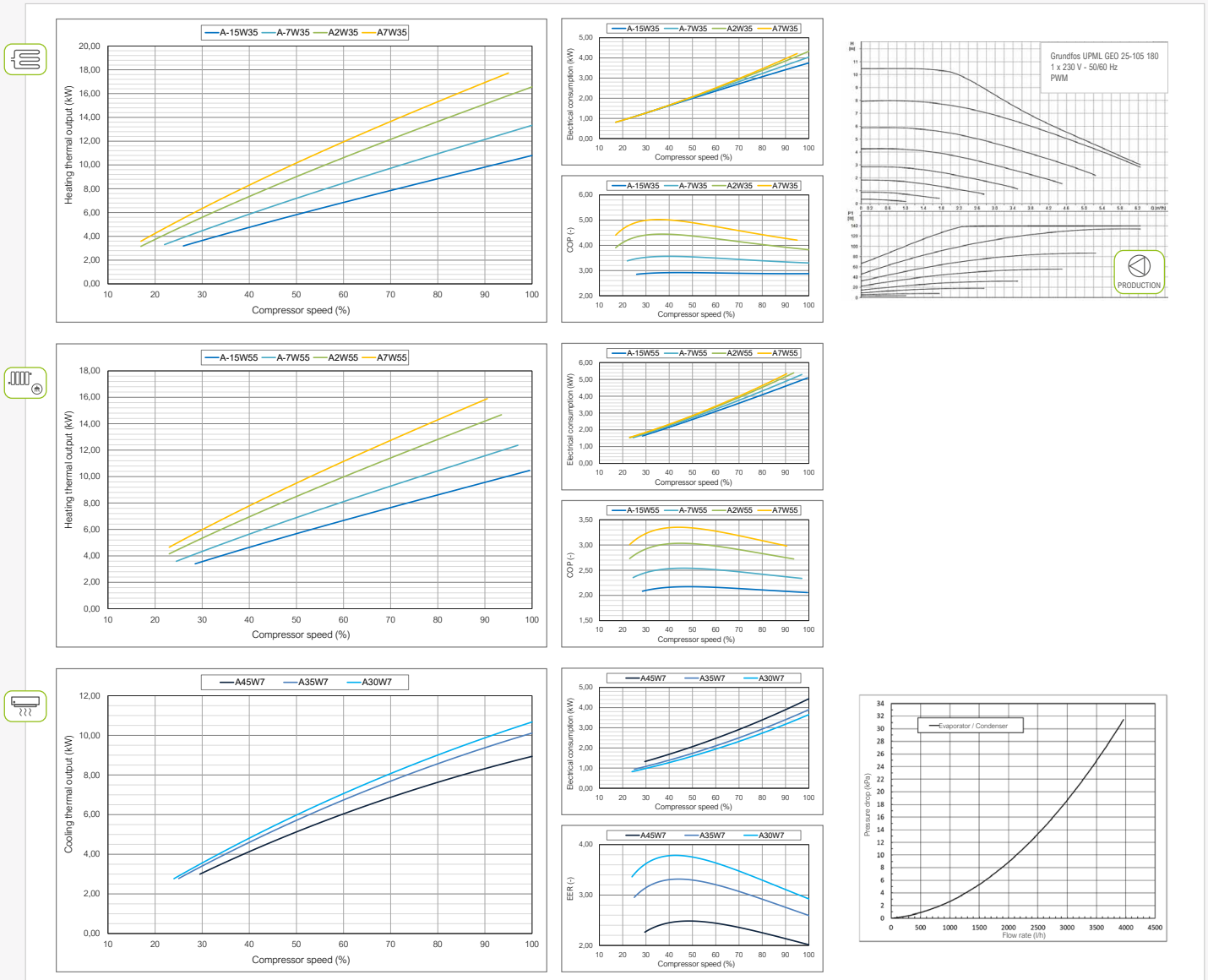

ecoAIR+ EVI

Residential range

Power ranges

ecoAIR+ EVI 4-20 kW



Monobloc heat pump

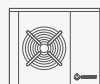

Outdoor unit
ecoAIR+ EVI



Indoor unit
CM / HK

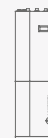

Indoor unit
HK-Compact

Services



DHW



Heating



Cooling



Pool

Indoor units

CM

Controller
Display

HK-EH

Controller
Display
Filling kit & filter
DHW 3-way valve
Support electrical heater

HK-Compact-EH

Controller
Display
Filling kit & filter
DHW 3-way valve
Support electrical heater
165l stainless steel DHW tank
Expansion vessel & safety valve



Inverter technology

Power ranges: 4-20 kW

Unique EVI technology by means of the Flash Tank system allowing to offer the best performances even in the most unfavourable conditions

Hot water production temperatures up to 65°C

Domestic hot water production

Heating and pool production

Integrated active cooling production

Modulating speed fan

Internet connection through the ecoSMART Easynet

Integrated photovoltaic hybridisation

Single-phase (230V) or three-phase (400V) power supply

Unique performances



DHW production and Heating

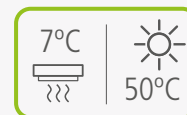

Cooling

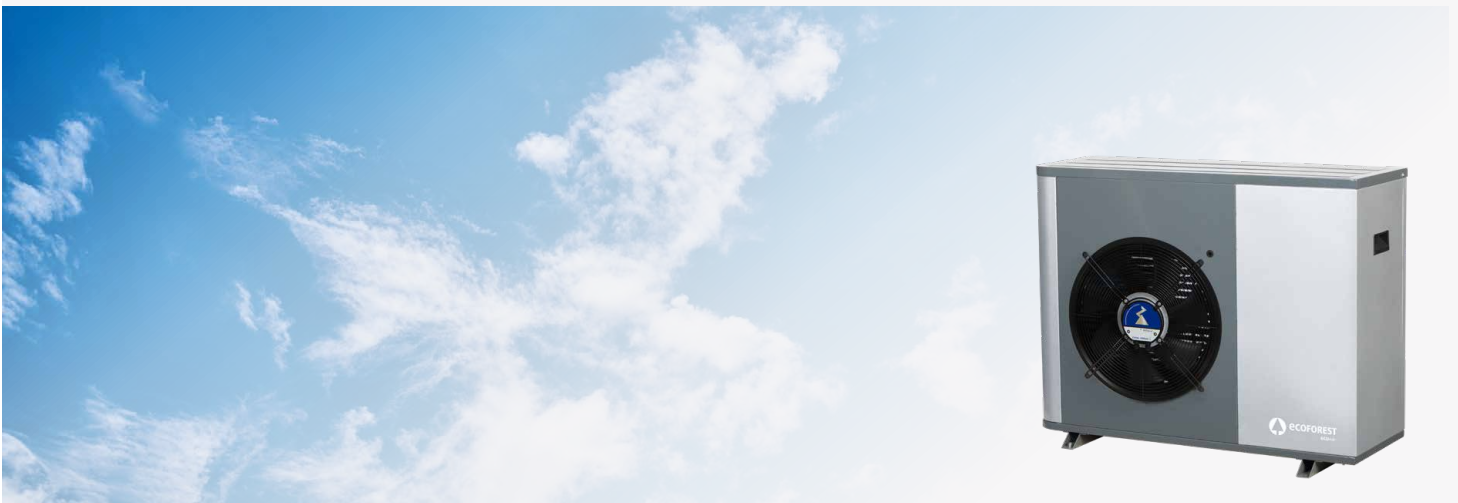

Indoor units

CM / HK / HK-Compact

- Indoor hydraulic units to be used in combination with ecoAIR+ EVI monobloc aerothermal heat pumps.
- CM, HK & HK-Compact: including the electrical box that allows to control the heat pump.
- HK & HK-Compact: including the main hydraulic components of the installation in several combinations.
- HK-Compact: integrating a 165l stainless steel DHW tank.
- Plug&play compact units that make the hydraulic system simpler and the installation easier.
- Single-phase control electrical box.
- Single-phase or Three-phase optional support electrical heater.

SPECIFICATIONS ecoAIR+ EVI INDOOR UNITS		UNITS	CM	HK-EH	HK-Compact-EH
APPLICATION	Place of installation	-		Indoors	
	DHW	-	✓	✓	✓
	Heating and Pool	-	✓	✓	✓
	Cooling	-	✓	✓	✓
INTEGRATED HYRAULIC COMPONENTS	Filling kit and filter	-	-	✓	✓
	DHW three-way valve	-	-	✓	✓
	Support electrical heater	-	-	✓	✓
	Separation plate heat exchanger	-	-	-	-
	Secondary circuit circulation pump	-	-	-	-
	Stainless steel DHW tank	-	-	-	✓
	Primary / Secondary expansion vessel	-	-	-	✓(12l)
OPERATION LIMITS	Production circuit pressure	bar	-	-	-
	DHW tank volume	l	-	-	165
	DHW tank maximum pressure	bar	-	-	8,0
	DHW tank maximum temperature	°C	-	-	80
CONTROL ELECTRICAL DATA	1/N/PE 230 V / 50-60 Hz ¹	-		✓	
	Recommended external protection	-		C5A	
	Transformer primary circuit fuse	A		0,5	
	Transformer secondary circuit fuse	A		2,5	
ELECTRICAL DATA: INTEGRATED SUPPORT ELECTRICAL HEATER	Supply: 1/N/PE 230Vac / 50-60 Hz ¹	-	-		✓
	Número de elementos	-	-		1-2-3
	Recommended external protection 1-2-3	-	-		C10A-C16A-C20A
	Maximum power consumption 1-2-3	kW	-		1,3-2,7-4,0
	Maximum current consumption 1-2-3	A	-		6,3-12,6-18,9
	Supply: 3/N/PE 400Vac / 50-60 Hz ¹	-	-		✓
	Recommended external protection	-	-		C10A
	Maximum power consumption	kW	-		4,0
	Maximum current consumption	A	-		6,3
Correction of cosine Ø	-	-		0,96/1	
DIMENSIONS/WEIGHT	Height x width x depth	mm	600x400x158		1770x595x678
	Empty weight (without assembly)	kg	15	44	130

1. The admissible voltage range for proper operation of the heat pump is $\pm 10\%$.

Dimensions and hydraulic connections

Indoor unit - CM / HK / HK-Compact

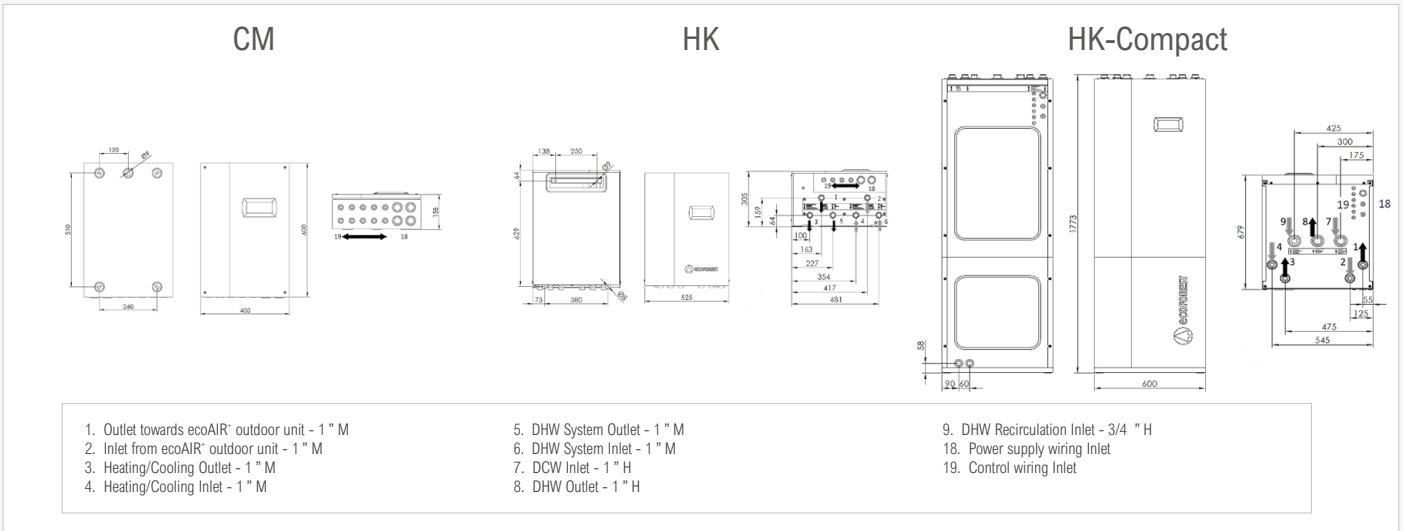

Hydraulic characteristics

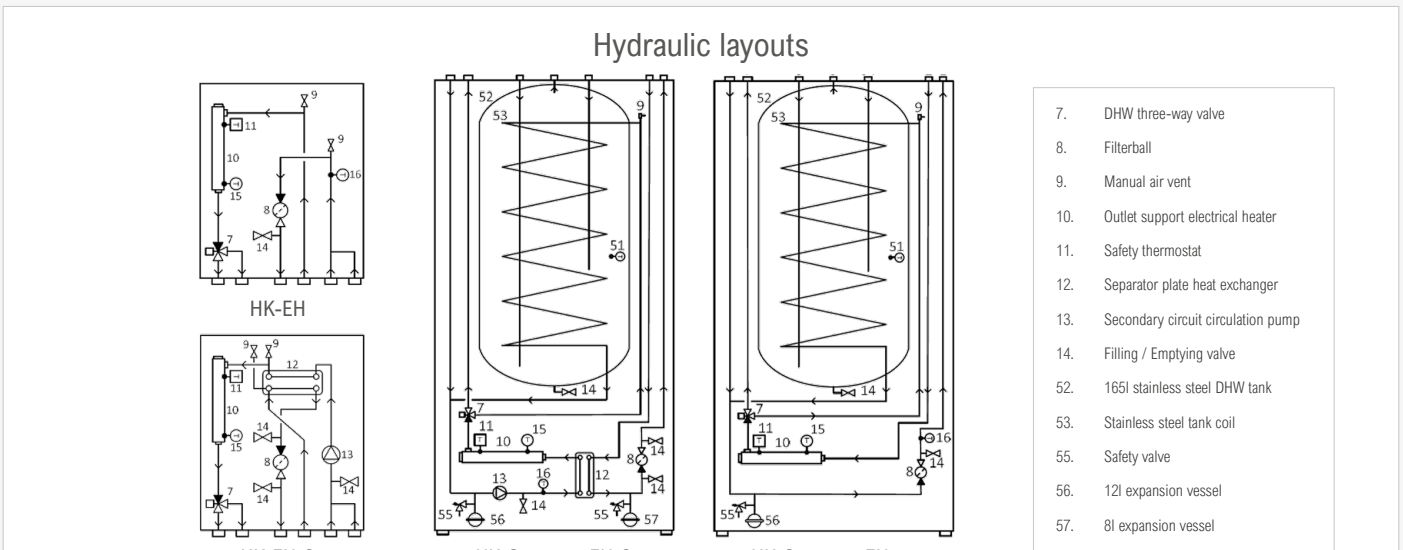

Models including hydraulic separation: HK-EH-S / HK-Compact-EH-S

Separation plate heat exchanger
Thermal power

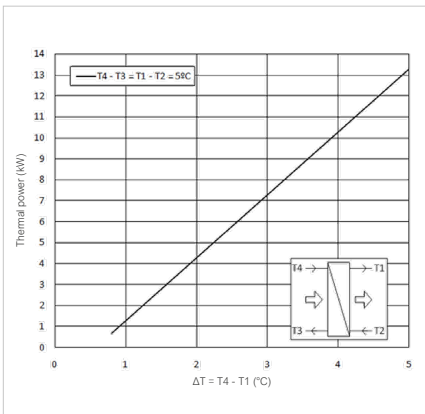

Separation plate heat exchanger
Pressure drop

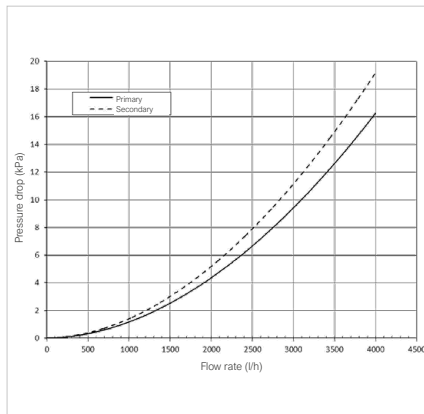

Secondary circuit circulation pump
Pressure drop, thermal power and flow rate

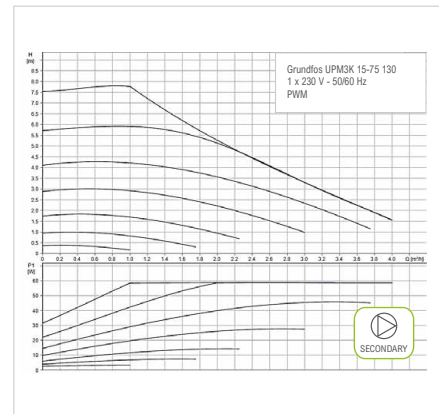

ecoAIR+ EVI 4-20

- Modulating thermal power control within a wide range (17-100%) and modulating flow rate control of the production circuit (20-100%).
- EVI technology by means of Flash Tank system.
- Inverter technology and scroll compressor.
- Compact design including the production circulation pump in the outdoor unit. Hydraulic connection within the outdoor unit and the indoor unit.
- Integrated management of up to 3 different emission temperatures, 2 buffer tanks (heating and cooling), 1 DHW tank, 1 pool and hourly control of DHW recirculation.
- Integrated management of simultaneous heating/cooling emission, according to scheme.
- Integrated management of external On/Off or modulating auxiliary systems, such as electrical heaters, On/Off boilers or modulating boilers.
- Integrated active cooling.
- Selection of the indoor unit depending on the installation needs.
- Single-phase and Three-phase versions available.
- Integrated photovoltaic hybridisation.
- Integrated energy meters to measure the electrical consumption, the heating/cooling thermal power, the COP and the monthly and annual SPF.

SPECIFICATIONS ecoAIR+ EVI 4-20		UNITS	
APPLICATION	Place of installation	-	Outdoors
	Type of brine system ¹	-	Air source
	DHW, Heating and Pool	-	✓
	Integrated Active cooling	-	✓
PERFORMANCE	Modulation range of the compressor	%	17 to 100
	Heating power output ² , A7W35	kW	4,4 to 20,5
	COP ² , A7W35	-	5,0
	Heating power output ² , A7W55	kW	8,8 to 20,5
	COP ² , A7W55	-	3,3
	Active cooling power output ² , A35W7	kW	4,0 to 14,8
	EER ² , A35W7	-	3,3
	Max. DHW temperature without / with support ⁵	°C	63 / 70
	Noise power emission level ⁶	db	63
	Energy label / rjs / SCOP W35 average climate control	-	A+++ / 178% / 4,56
Energy label / rjs / SCOP W55 average climate control	-	A++ / 150% / 3,85	
OPERATION LIMITS	Distribution / Set heating outlet temperature range	°C	10 to 63 / 20 to 60
	Distribution / Set cooling outlet temperature range	°C	5 to 35 / 7 to 30
	Outdoor temperature range	°C	-15 to 50
	Minimum / Maximum refrigerant circuit pressure	bar	2,0 / 45,0
	Production circuit pressure	bar	0,5 to 3,0
WORKING FLUIDS	R290 Refrigerant load	kg	3,5
	Compressor oil type / load	kg	POE / 1,48
CONTROL ELECTRICAL DATA	1/N/PE 230 V / 50-60 Hz ⁸	-	✓
	Maximum recommended external protection ⁹	-	C5A
	Transformer primary circuit fuse	A	0,5
	Transformer secondary circuit fuse	A	2,5
ELECTRICAL DATA: SINGLE-PHASE	1/N/PE 230 V / 50-60 Hz ⁸	-	✓
	Maximum recommended external protection ⁹	-	C40A
	Maximum consumption ² , A7W35	kW / A	5,3 / 23,0
	Maximum consumption ² , A7W55	kW / A	7,8 / 34,1
	Minimum / Maximum starting current ⁷	A	10,8
	Correction of cosine Ø	-	0,87/1
ELECTRICAL DATA: THREE-PHASE	3/N/PE 400 V / 50-60Hz ⁸	-	✓
	Maximum recommended external protection ⁹	-	C16A
	Maximum consumption ² , A7W35	kW / A	5,3 / 7,7
	Maximum consumption ² , A7W55	kW / A	7,8 / 11,4
	Minimum / Maximum starting current ⁷	A	3,6
	Correction of cosine Ø	-	0,87/1
DIMENSIONS/WEIGHT	Height x width x depth	mm	1250x1240x635
	Empty weight (without assembly)	kg	177

1. Outdoor air-to-water monobloc unit.

2. In compliance with EN 14511, this includes the consumption of the circulation pumps and the compressor driver.

3. Considering brine and production flow rates in compliance with EN 14511.

4. Considering a heat slope from 20°C to 50°C in absence of consumption.

5. Considering support provided by the emergency electrical heater or the HTR system. Maximum DHW temperature with the HTR system can be limited by the compressor discharge temperature.

6. In compliance with EN 12102, this includes the acoustic insulation kit of the compressor.

7. Starting current depends on the working conditions of the hydraulic circuits.

8. The admissible voltage range for proper operation of the heat pump is ±10%.

9. Maximum consumption can vary significantly according to working conditions, or if the compressor's operation range is restricted. Consult the technical service manual for more detailed information.

10. Certification in process.

Dimensions and hydraulic connections

Outdoor unit - ecoAIR+

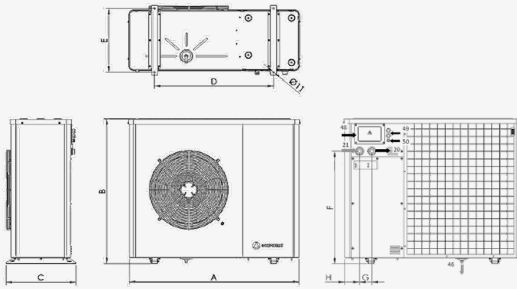

MODEL	DIMENSIONS (mm)							
	A	B	C	D	E	F	G	H
ecoAIR+ EVI 4-20	1350	1254	625	800	580	975	80	105

- 20. Heating/Cooling Outlet - 1 1/4" M
- 21. Heating/Cooling Inlet - 1 1/4" M
- 46. Drain - 15 mm
- 48. Electrical connections box
- 49. Power supply wiring Inlet
- 50. Control wiring Inlet

Operational chart

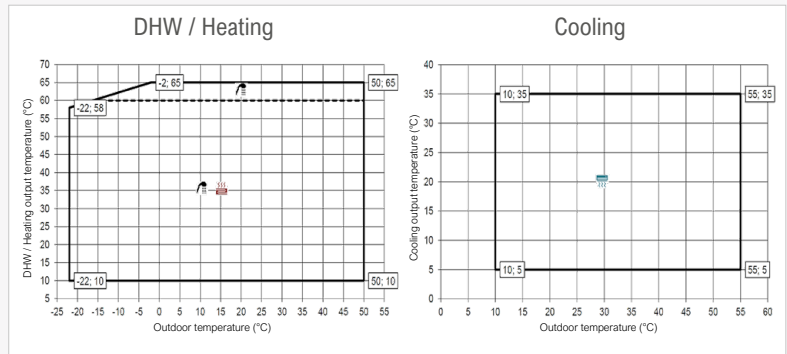

Installation management

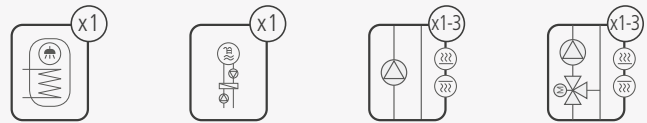

Performance curves

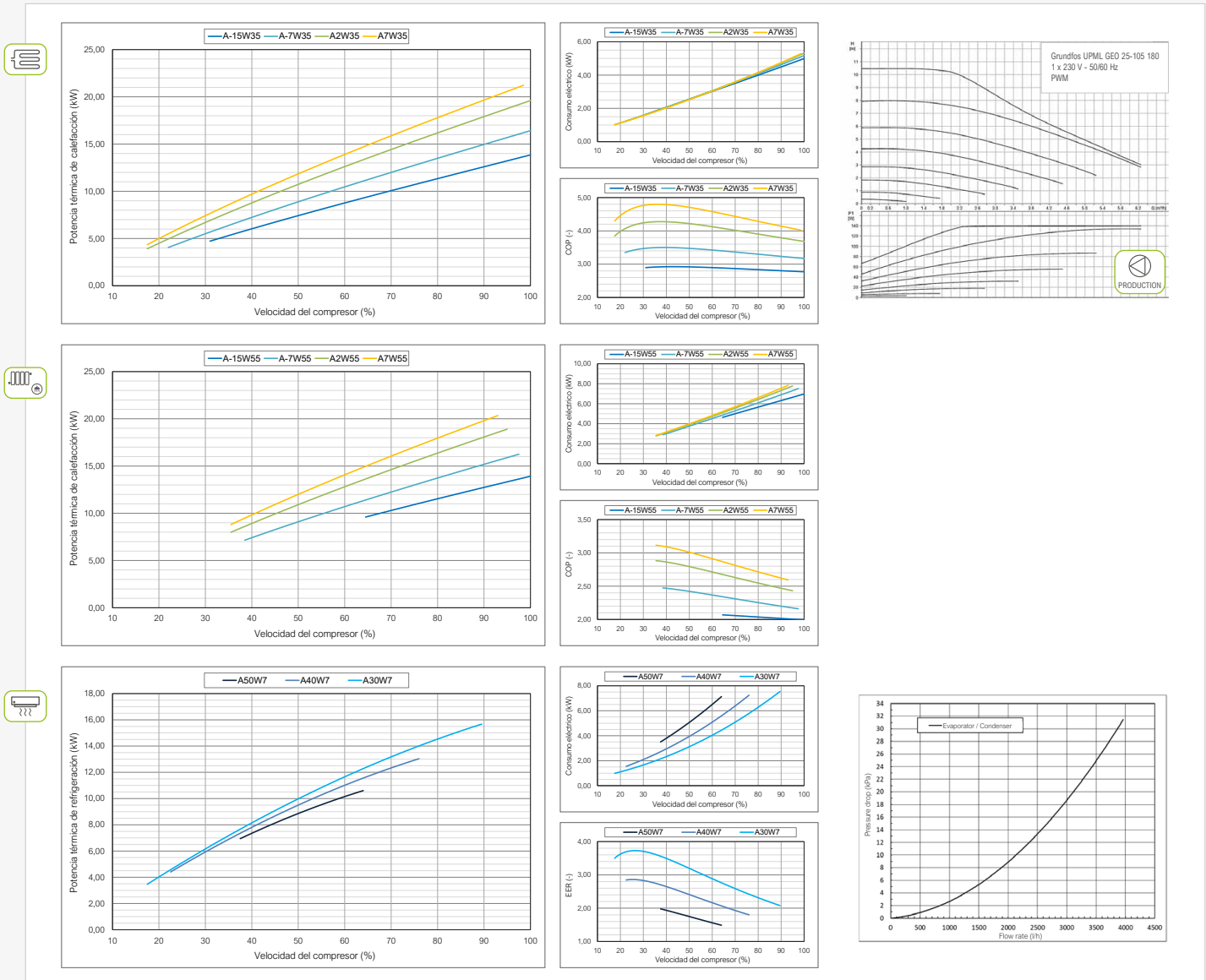

Notes

Notes

ECOFOREST GEOTERMIA, S.L.

Parque Empresarial Porto do Molle · Rúa das Pontes 25
36350 Nigrán - Pontevedra (Spain)

+34 986 262 184

www.ecoforest.com

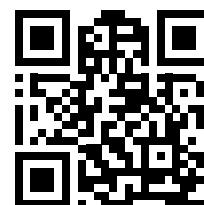

Ecoforest shall not be held responsible for any error contained in this these technical data sheets and reserves the right to make any modifications it deems necessary for both technical and commercial reasons at any time and without prior notification. The availability of any equipment described in this document shall always be confirmed by Ecoforest. The inclusion of the equipment in this catalogue does not imply an immediate availability.

