

Catalogue

Heat Pumps

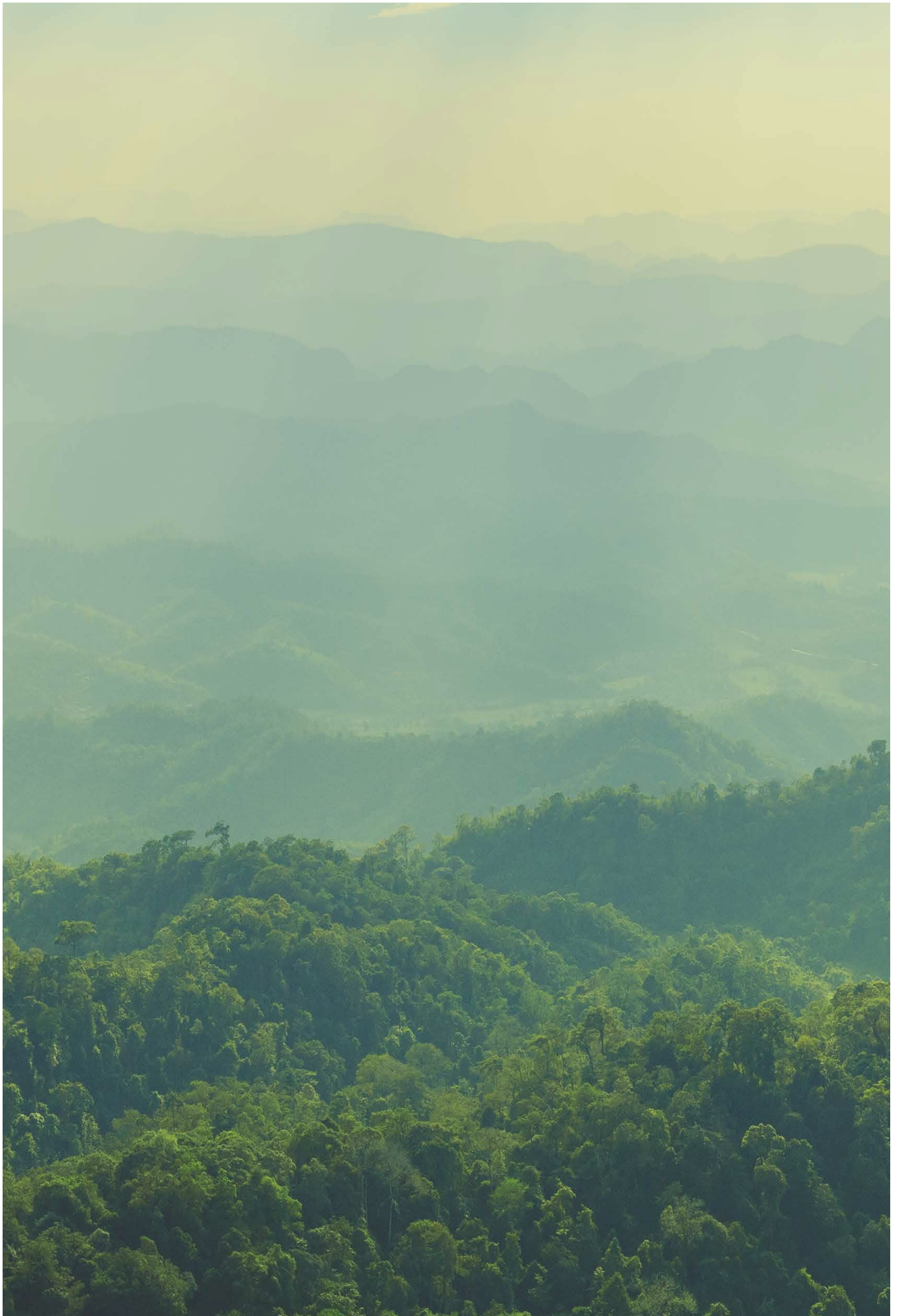



Our history

The history of Ecoforest begins in 1959 thanks to the vision and determination of Jose Carlos Alonso, who would become its founder and today its president. A trip to the United States made him discover pellets, a fuel that at that time was unknown in Europe. As a result, Ecoforest soon became the first distributor of pellet stoves in Europe, laying the foundations for a market that is now fully consolidated.

Some years later, in the 1990s, we went a step further and became the first European manufacturer of pellet stoves, as well as the inventors of the pellet hydro-stove, which allowed us to position ourselves internationally as a reference in the HVAC and renewable energy sector.

After more than 7 years of research and experimentation in collaboration with the University of Vigo, in 2012 we presented a new range of products, our ecoGEO heat pumps, making us the first Spanish manufacturer of ground source heat pumps and the first European manufacturer to incorporate modulating compressors (Inverter Technology) and 4-way valves for the production not only of heating or DHW, but also cooling, representing a turning point in the sector.

Always focusing on technological differentiation, in 2013, we developed our air source with water-to-water heat pumps, an exclusive type of air source, in which we introduced innovative technologies like defrosting without compressor consumption or the possibility of the hybridization of collection

sources, for example, air and ground, getting the best of both, optimizing the performance and cost of the installations.

This was followed by our range of high power heat pumps in 2014 and our peak performance range tracking technology to optimise cascade operation in 2015.

Our energy managers for the hybridisation of our heat pumps with photovoltaic systems (the perfect combination of present and future) in a unique and much more powerful way, in fact patented by us, as well as our family of air-to-water heat pumps (our ecoAIR range) in which we have already introduced the latest advances in terms of refrigerants (100% natural), have been our most recent technological developments, and something that has enabled us to position ourselves as one of the fastest growing manufacturers in Europe in recent years.

"Ecoforest offers all types of HVAC solutions using renewable energies, and is the only Spanish manufacturer of ground source heat pumps and leader in sales in Spain".





Why pay for something that is free?

Without realising it, we all come across forms of green energy everyday, more infact than our society will ever need. Most people now know about the benefits of solar pannels and wind turbines, but few realise we have the technology to take advantage of earth we walk on, or the air we breathe.

A huge part of the energy we use in our homes now goes towards heating and cooling. Heat pumps are able to utilise the energy that lays dormant all around us to power our heating, DHW and even cooling. All this is done at no extra cost to the planet, making it an invaluable technology for our society.

■ ÍNDEX

ECOFORREST HEAT PUMPS	6
AIR SOURCE	10
GROUND SOURCE	20
PHOTOVOLTAIC HYBRIDIZATION	30
REFERENCE INSTALLATIONS	32

■ ¿Why choose Ecoforest ?

INNOVATION & DEVELOPMENT

At Ecoforest we have a strong technical and academic background, this has influenced our decision to spread our own experience, and to publicize the advances obtained by our R&D department in our laboratories and in collaborations with foundations.

ENGINEERING & QUALITY

All Ecoforest heat pumps are subject to exhaustive quality controls that start at the development / design stage and finish at the end of the assembly line.

ADVICE

Ecoforest's technical team is composed of engineers who can support you in projects requiring particular or complex solutions.

PRESCRIPTION

Ecoforest equipment, including heat pumps and biomass products have been introduced into price generator and design software such as CYPE engineers.

TAILORED TRAINING COURSES

The quality of our products is matched only by the training and knowledge of our professionals offer. For this reason, we periodically organize workshops and trainings so that this knowledge is translated into efficient installations and satisfied customers.

FAST REACTION

Ecoforest is characterized by fast reaction, both in customer service and problem solving. Our team is able to react to new projects in the shortest possible time, which presents a great competitive advantage.

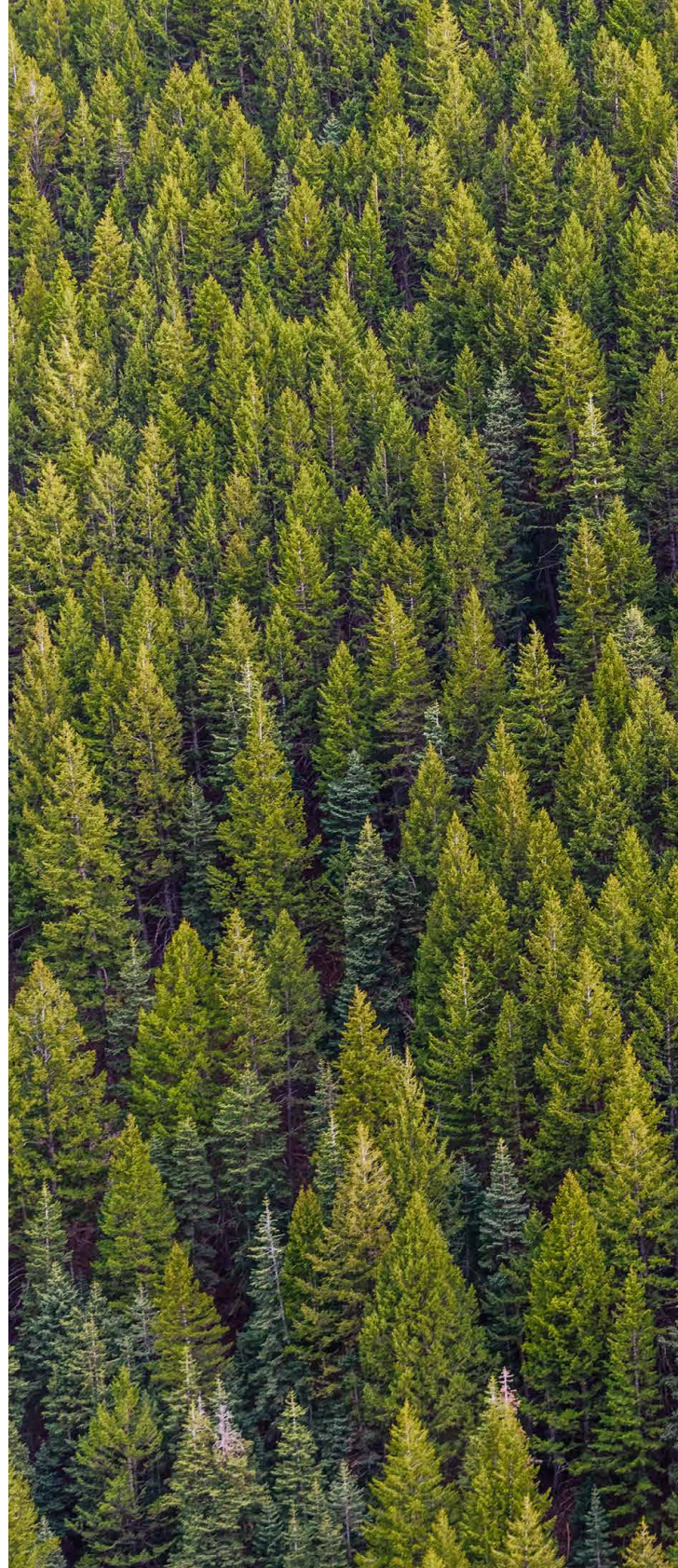

Ecoforest heat pumps

¿How does an ecoGEO heat pump work?



The system is based on the simple refrigeration cycle. It consists of transporting energy in the form of heat from one environment (which can be air, water or soil) to another. But why is the system so efficient?

The heat pump has the ability to absorb energy from external and free sources (ground, water and air). This characteristic makes it possible to multiply the electrical power needed to operate the compressor, transporting useful heat in a highly efficient way.

The performance (COP, in heat mode and EER, in cooling mode), will be the power delivered to the house between the electrical power that is consumed by the heatpump.

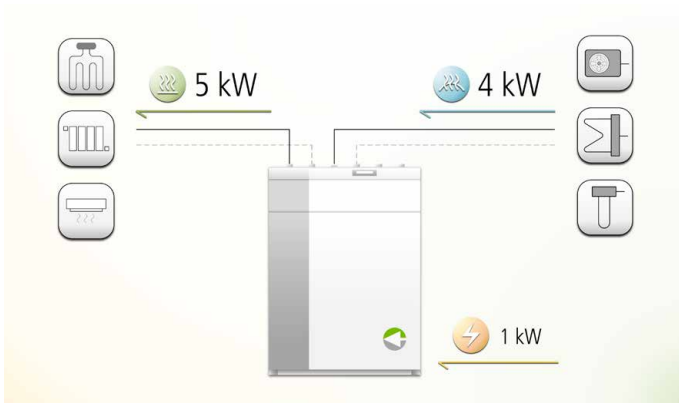

$$\text{COP} = \frac{\text{POWER GAINED}}{\text{POWER USED}} = \frac{5 \text{ kW}}{1 \text{ kW}} = 5$$

$$\text{EER} = \frac{\text{THERMAL POWER DELIVERED}}{\text{ELECTRICAL POWER CONSUMED}} = \frac{4 \text{ kW}}{1 \text{ kW}} = 4$$

Inverter technology : the modulating heat pump

Inverter technology, in contrast to conventional on/off technology, consists of controlling the speed of the compressor in order to vary the thermal power produced and the electrical power absorbed by the heat pump. The principal reason for using Inverter technology for compressor speed management is that it permits the operation of the heat pump to be adapted to the thermal demand of the building at any given moment, optimising its performance and reducing the seasonal electrical consumption of the unit.

When adapting the speed of the compressor, the power difference between the demand of the building and the power of the heat pump is reduced as the pump is able to provide the exact power at any given moment, also allowing for more flexible installations

able to adapt correctly to each installation and save some of the elements of the installation that would be necessary in the case of using an ON/OFF heat pump. This means that heat pumps with Inverter technology are not only more efficient, but also allow for more compact and economical installations.

Ecoforest has extensive experience in this technology, as it has developed all its products using it from the very first model, being the only manufacturer with a complete range of Inverter products.

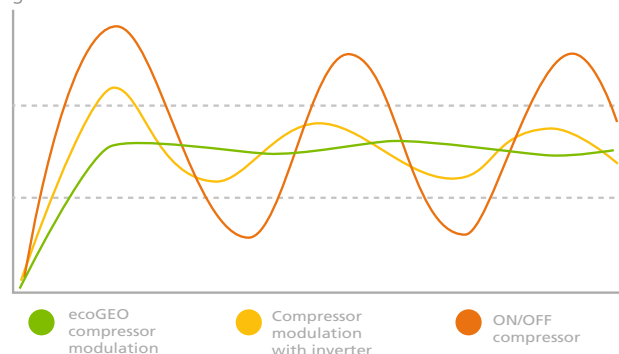

Ecoforest heat pumps

Advantages

- ECONOMICAL
- COMFORTABLE
- REMOTE CONTROL
- INTEGRAL MANAGEMENT
- QUIET
- MINIMAL MAINTENANCE
- EFFICIENT
- NO CO₂ EMISSIONS

Amortization of the installation vs traditional heating systems

The following comparison corresponds to a house with a thermal demand in heating of 10 kW in Madrid. Depending on the type of heat, fuel and performance generator, the consumption varies significantly, and ECOFOREST is the most ecological and economical solution.

Annual energy consumption (kWh)

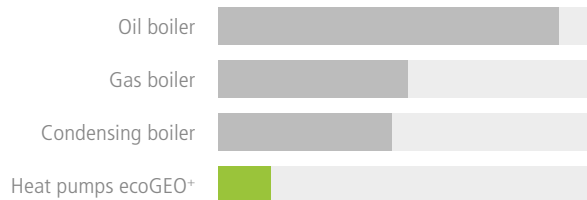

Performance (%)



The Ecoforest heat pump is the best option compared to the main types of conventional heating systems. The most important difference is the origin of the primary energy used by the heat pump, as it gets a large part of its energy from a renewable source that is not taken into account as consumption when calculating efficiency. For this reason, the efficiencies achieved by a heat pump are unattainable for other systems.

■ Ecoforest heat pumps



Air source

Air source heat pumps use the energy of the air. Ecoforest has developed two types of Air source heat pumps:

The ecoAIR⁺ monobloc heat pump, an innovative product on the monobloc air source heat pump market that guarantees unique performance even in the most unfavourable conditions and adapts to the needs of the installation at all times.

Another type of Air source is the ecoGEO⁺ & AU, a unique solution that combines an ecoGEO⁺ heat pump with an outdoor Air source unit (AU), providing extraordinary efficiency and even allowing for hybrid Ground source-Air source systems to achieve a perfect balance between investment and performance, a unique solution on the market.



Ground source

Ground source heat pumps make use of the energy contained in the ground. The temperature of the underground is stable all year round, which makes it possible to obtain very high performance all year round, independent of external weather conditions.

ecoGEO⁺ heat pumps are Ecoforest's Ground source heat pumps. These heat pumps have a very different technology, thanks to their inverter technology and control strategies that make it possible to achieve the most efficient and compact installations on the market.

This range includes products for domestic applications, such as ecoGEO⁺ Basic and ecoGEO⁺ Compact, as well as for commercial and industrial applications, ecoGEO⁺ HP, making it the most complete and advanced range of Ground source heat pumps on the market.

■ Ecoforest heat pumps



Photovoltaic hybridization

The ecoGEO+ and ecoAIR+ heat pumps incorporate hybrid management with electricity production systems from renewable sources, which reduces electricity consumed while optimising the operation of the heat pump in a unique way.

This exclusive management allows Ecoforest heat pumps to store, in the form of thermal energy, excess electricity from renewable sources, guaranteeing optimal consumption and minimising electricity consumption from the network. This patented technology makes it possible to exploit the full potential of renewable energies.

It is a unique system that also makes it possible to reduce the number of electric batteries required in a conventional photovoltaic or wind power installation, or even eliminate them completely.

Accessories

A heat pump needs to guarantee comfortable conditions, which is why all the details must be taken into account when installing the heat pump. The correct choice of the elements that will form the environment of the heat pump is as important as having an efficient heat pump.

Ecoforest provides its customers with the latest accessories for heat pumps, fully adapted to our products, in order to obtain the most efficient installations.

The Ecoforest range of accessories is specifically designed for use with ecoGEO+ and ecoAIR+ heat pumps. All the accessories offered by Ecoforest have been tested to determine the best solutions for the installations.



Air source

ecoAIR+

Monobloc Inverter air-to-water heat pumps

A complete range for domestic applications with compact units that use the most advanced technology to guarantee the best comfort in any weather condition.



ecoGEO+ & AU

Inverter water-to-water heat pumps with Air source collection

A unique solution that combines a water-to-water heat pump with an air unit for total hydraulic collection, resulting in higher performance than monoblock units. This range covers both domestic and industrial applications.



Air source

How does air source work?

Air source heat pumps use the outside air as an energy source, producing domestic hot water, heating and cooling. Using the thermodynamic cycle, they use the energy in the air to produce the thermal energy required by the building.

Air source heat pumps are more economical than Ground source heat pumps, but their efficiency is influenced by external environmental conditions and their annual efficiency is slightly lower than that of Ground source heat pumps.

Installation is simpler than ground source, requiring only the installation of an outdoor unit that collects energy from the air and an indoor unit.

Air source is a solution with a lower initial investment than Ground source and a performance slightly lower, but still much higher than that of traditional heating systems.

Types of air source heat pumps



Air-to-Air

Air-to-air heat pumps exchange heat with the outside air and deliver this heat to the installation by means of hot or cold air, the best known type of Air source heat pump is the commonly known air-conditioning.



Air-to-Water

Air-to-water heat pumps exchange heat with the outside air and emit this heat to the installation through hot or cold water. This type of Air source allows us to heat radiators, underfloor heating or fan coils, in addition to heating DHW.

Ecoforest air-to-water heat pumps are monobloc heat pumps. The monobloc concept means that all components of the heat pump are located in the outdoor unit and the connection between the outdoor unit and the building is fully hydraulic and not a refrigerant connection as in other cases.

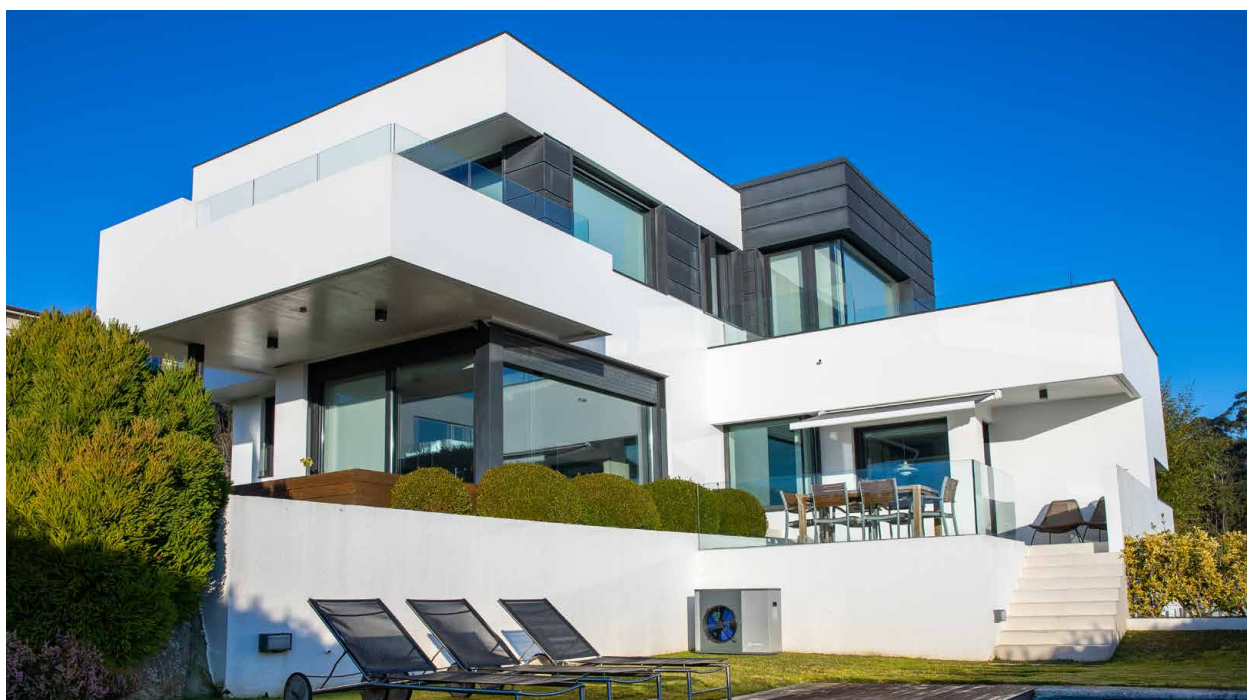

■ Air source

ecoAIR⁺ PRO

Monobloc Inverter air-to-water heat pumps with natural refrigerant R290



- Inverter technology and natural refrigerant R290
- Modulating thermal power (20-100%) and modulating flow rate control of the production circuit (20-100%)
- Hydraulic kits for compact systems: three-way valve for DHW, filter, filling kit, heat exchanger, circulation pump and heating element and buffer tank for DHW
- Integrated active cooling in all models
- Interated energy meters
- Performance in extreme conditions: the use of propane as a refrigerant guarantees production temperature and power stability even in the most unfavourable conditions.
- Control throught Internet
- Possibility of hybridisation with photovoltaic energy
- ECOFOREST control strategy
- Control of external auxiliary equipment (gas boilers, heating elements, etc.)
- DHW recirculation control

Services



DHW



Heating



Cooling



Pool

Emissions systems



Radiators



Fancoils



Radiant and cooling floor

Installation management

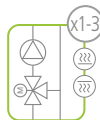
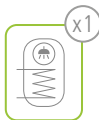

Features



Power ranges

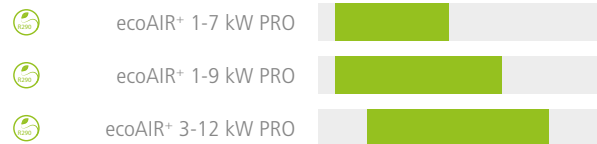

Monobloc heat pump

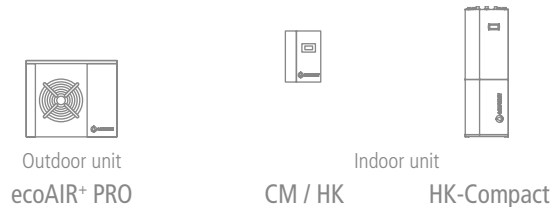

Propane, the innovation is natural

The use of propane (R290) to satisfy the thermal needs of buildings is not new, as this natural gas has historically been used for the production of heating and domestic hot water by combustion.

The use of R290 is already present in a significant number of refrigerators. The reasons why this gas can be so interesting as a refrigerant are the following:

- Natural gas not produced synthetically
- Almost zero greenhouse effect (GWP: 3)
- Very economical
- Unique performance and efficiency
- Excellent working temperatures

These characteristics are perfectly adapted to the operating conditions of Air source heat pumps, as they allow them to guarantee their performance even in the most unfavourable conditions.

In addition, propane is a natural refrigerant with almost zero associated greenhouse emissions. This makes this refrigerant the solution for the future of Air source energy for both new homes and retrofit.

When changing a boiler to a heat pump, the key factor for the correct operation of the installation is the **high temperature required by the radiators**. Traditional Air source heat pumps are unable to produce these high temperatures and for this reason conventional Air source systems do not work well in this type of installation.

The ecoAIR+ PRO heat pump allows you to reach **more than 70°C without additional electrical support**, even at the most extreme temperatures. The technology developed by Ecoforest makes the replacement of an old boiler very simple and economical, while guaranteeing the best comfort.



■ Air source

ecoAIR⁺ EVI

Monobloc Inverter air-to-water heat pump with technology EVI



- Inverter technology and Scroll compressor
- Power ranges: 4-20 kW
- Domestic hot water production with external DHW tank
- Production of heating and swimming pool
- Integrated production of active cooling
- EVI technology to get the best performance even in unfavorable conditions
- Unique system with Flash tank
- Control through Internet with the ecoSMART EasyNet
- Hybridization with photovoltaic energy
- Single-phase (230V) or three-phase (400V) power supply
- Integrated energy and performance meters
- Control of external auxiliary equipment (gas boilers, heating elements, etc.)
- DHW recirculation control

Services



DHW



Heating



Cooling



Pool

Emissions systems



Radiators



Fancoils



Radiant and cooling floor

Installation management

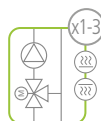
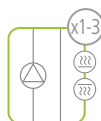

I Characteristics



Power ranges

ecoAIR+ EVI 4-20 kW



Monobloc heat pump

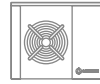

Outdoor unit
ecoAIR+ EVI



Indoor unit
CM / HK



Indoor unit
HK-Compact

EVI technology, performance in all conditions

The EVI system makes it possible to achieve significantly higher temperatures and performance than other conventional Air source technologies.

The EVI Scroll compressor used in the ecoAIR+ EVI heat pump, designed for heat pumps, allows the gas to be re-injected into the compressor in an optimal way, achieving higher temperatures. The principal advantages of this technology are:

- Improvement of the capacity and the output temperature
- Improvement of the seasonal performance
- Higher utilization of the heating capacity of the system

These characteristics are perfectly adapted to the working conditions of Air source heat pumps, as they allow them to guarantee their performance even in the most unfavourable conditions, an essential requirement for both new homes and renovations.

The ecoAIR+ EVI heat pump can reach temperatures of over 60°C with no additional electrical support, even at the most extreme temperatures. Thanks to the technology developed by Ecoforest, the replacement of an older boiler is very simple and economical, while guaranteeing maximum comfort.



DHW and Heating

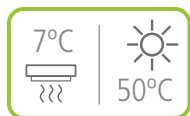

Cooling

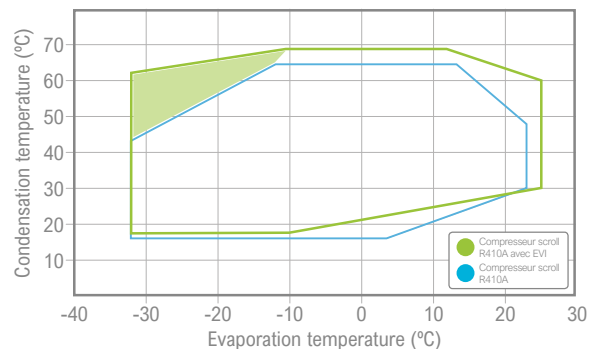

Air source

ecoGEO⁺ & AU

Inverter water-to-water heat pumps with Air source collectors



- Inverter technology and Scroll compressor
- Power ranges: 1-6 kW / 1-9 kW / 3-12 kW / 5-22 kW / 12-40 kW / 15-70 kW / 25-100 kW
- Domestic hot water production
- Production of heating and swimming pool
- Integrated production of active cooling
- Control through Internet with the ecoSMART Easynet
- Hybridization with photovoltaic energy
- Natural refrigerant in ecoGEO PRO models with DHW production temperatures up to 75°C.
- Integrated cascade control up to 3 units
- Single-phase power supply (230V)

Services



DHW



Heating



Cooling



Pool

Emissions systems



Radiators



Fancoils



Radiant and cooling floor

Installation management

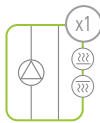
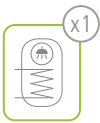

I Features



Power ranges

ecoGEO+ Basic & Compact

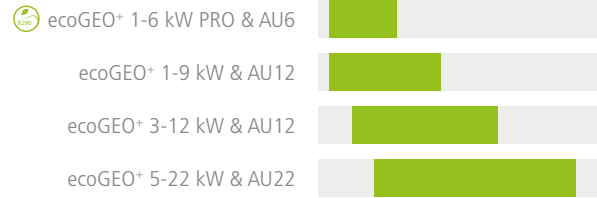

ecoGEO+ HP

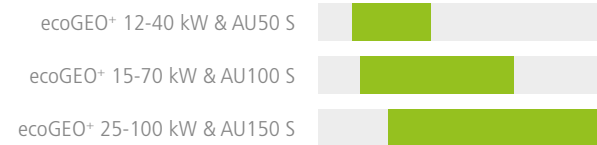

Collection / Production

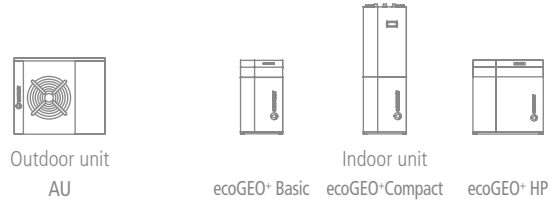

ecoGEO+ & AU, a different type of air source energy

The combination of ecoGEO+ heat pumps with hidraulic air source units (AU) is a unique solution with many advantages over conventional Air source heat pumps.

The main components are situated in the indoor module and are not exposed to the weather, which guarantees a long service life. The refrigerant charge, which is also limited to the indoor unit, is much lower than in traditional Air source units. In addition, there is no distance limitation between the outdoor unit and the heat pump, which is indoors, as in other types of systems. The noise level of the outdoor unit is considerably lower than that of conventional Air source heat pumps, as the unit has no compressor inside.

A unique defrosting system, totally hydraulic and with the compressor stoped, reduces the duration of defrosting cycles and

their frequency, all without activating auxiliary electrical elements, and allows to achieve high performances. anuales excepcionales. In addition, for domestic applications, the combination of ecoGEO+ Basic and ecoGEO+ Compact with air source outdoor units (AU) makes it possible to take advantage of HTR technology. This characteristic makes the system a more efficient solution, as the energy used for defrosting is produced free of charge during heating production, which also significantly increases the efficiency of the system.

These advantages make this system an ideal solution in Air source, with a number of advantages over traditional Air source systems.



Ecoforest air source solutions

ecoAIR+

All-in-one, HK-Compact

This configuration, which combines an ecoAIR+ with the HK-Compact indoor module, it's perfect for compact and economical installations. The HK-Compact indoor unit integrates all the main elements of the hydraulic system, including a 165-litre stainless steel hot water tank.

The ecoAIR+ heat pump can manage up to 3 shunt groups with different temperatures. This scheme is suitable for managing two zones (e.g. an underfloor heating and cooling circuit and a radiator circuit) which can be connected without the need for a buffer tank thanks to the wide modulation ranges of the ecoAIR+ units.



Maximum versatility, HK

This configuration, which combines an ecoAIR+ with the HK indoor module, allows the installation to be adapted to every need, providing all the services required: DHW, heating, cooling and swimming pool. The HK indoor unit integrates most of the elements of the hydraulic installation, and it is sufficient to fit the specific components required for each case.

The image below shows a DHW tank for high domestic hot water consumption and direct heating/cooling production, with the circulation pumps, filters and valves integrated in the HK unit.

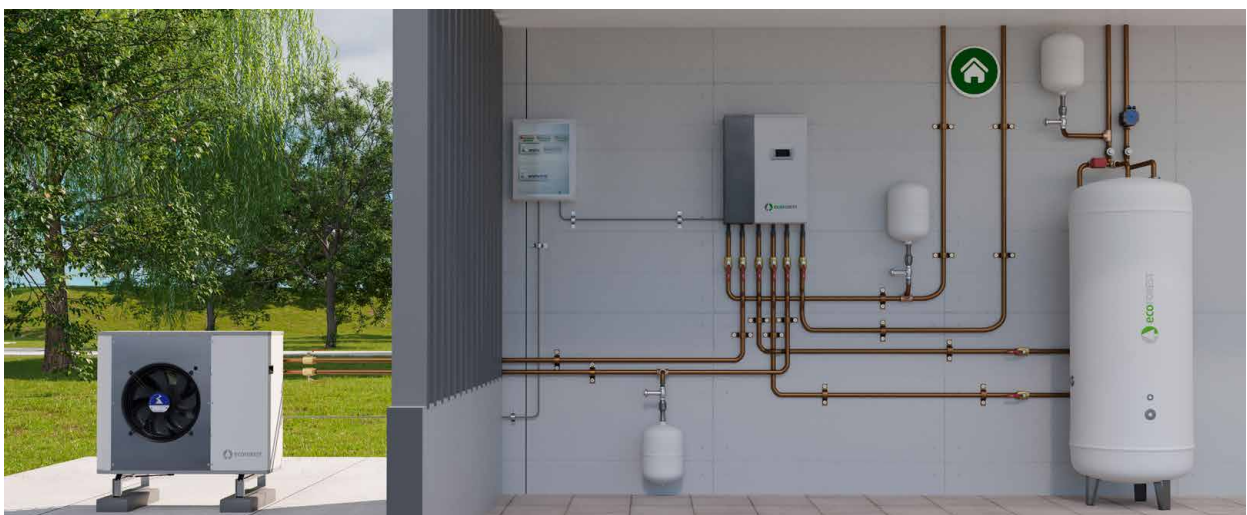

ecoGEO+ & AU

Water-to-water heat pumps with air source

The ecoGEO+ Basic and Compact units (Models 2 and 4) can use air source collection systems using the AU outdoor units, making possible Air source installations where the heat pump is indoors and the outdoor unit is a simple water exchanger.

The installation shown in this example combines an ecoGEO+ Compact heat pump with an AU12, guaranteeing the production of DHW (165l stainless steel tank integrated in the unit), heating/cooling in several outputs (without the need for a buffer tank thanks to the wide modulation ranges) and swimming pool, all controlled by the heat pump.



Hybrid collection system: Ground and air source



The ecoGEO+ units can also manage a hybrid system of ground source and air source collection, a unique Ecoforest technology that allows optimal use of both sources at any time.

This has several advantages: on the one hand, the number/length of Ground source probes required will be significantly reduced compared to a fully Ground source system, resulting in a more economical system. On the other hand, the efficiency of the system can be higher than that of a 100% Ground source system because the management will allow each source to be exploited according to its efficiency at any given time.

Individual heat pump and common collection system, ideal for multiple dwellings

This configuration is perfect for the implementation of energy transition measures in buildings. It consists of a single Air source collection for the whole building, usually installed on the roof or in an available area, which can consist of a single unit covering all needs or several units distributed according to the available space. Each flat has its own heat pump, an ecoGEO+ Compact for example, which requires only 1m² of floor space, and can make individual use of the HVAC in each flat. In addition, the energy meter is also simplified.

This type of installation offers higher performance than conventional HVAC systems, without the classic heat loss of distribution columns, and absolute individual comfort. It is also a very economical system, as all units share the collector.



Ground source

ecoGEO+ Basic & Compact

Inverter water-to-water heat pumps

A complete range for domestic installations with compact units that use the most advanced technology to guarantee the best comfort.



ecoGEO+ HP

Inverter water-to-water heat pumps

A complete range for installations that require greater thermal power, incorporating units that use the most advanced technology to guarantee the best comfort.



■ Ground source

How does ground source energy work?





The ground source heat pump extracts energy from the ground or water for heating, cooling and domestic hot water production. The ground source heat pump uses the thermodynamic cycle to provide these different services, for heating it extracts heat from the ground or water and introduces this heat into the building, and for cooling it extracts heat from the building and transports it to the ground or water source.

Ground source heat pumps are also known as water-to-water heat pumps because they extract heat from the ground or a water source through a water circuit and transfer this energy to the building also

through a water circuit. Ground source systems have no visual or acoustic impact. Ground source installations require a higher initial investment than Air source systems, due to the work associated with the collection circuit.

On the other hand, ground source heat pumps have a higher efficiency than air source heat pumps. This allows for greater energy savings, making Ground source more cost-effective in the long run.

Types of collection systems

			
Vertical closed loop	Horizontal closed loop	Open loop	Other
These collectors consist of boreholes buried at depths generally between 80m and 150m.	These boreholes consist of probes buried horizontally at a depth of 1 to 2 metres.	This system consists of an open circuit of water collected from the water table and after passing through an exchanger allows the heat pump to extract its energy.	Ground source baskets, thermoactive piles, Ground source pillars, ...

Ecoforest ground source heat pumps ecoGEO⁺ can be paired to any type of collection system thanks to their control strategies that adapt their operation to the characteristics of each type of source.



■ Ground source

ecoGEO⁺ Basic & Compact PRO

Inverter water-to-water heat pumps with natural refrigerant R290



- Inverter technology
- Power ranges: 1-6 kW
- Heating, active cooling, passive cooling, DHW and swimming pool production
- Internet control with the ecoSMART easynet kit
- Integrated photovoltaic hybridization
- Natural refrigerant in ecoGEO PRO models with DHW production temperatures of up to 75°C
- Integrated cascade management up to 3 units
- Single-phase (230V) power supply
- Integrated energy and performance meters
- Control of external auxiliary equipment (gas boilers, heating elements, etc.)
- Hybrid collection systems control
- DHW recirculation control

Services



DHW



Heating



Cooling



Pool

Emissions systems



Radiators



Fancoils



Radiant and cooling floor

Installation management

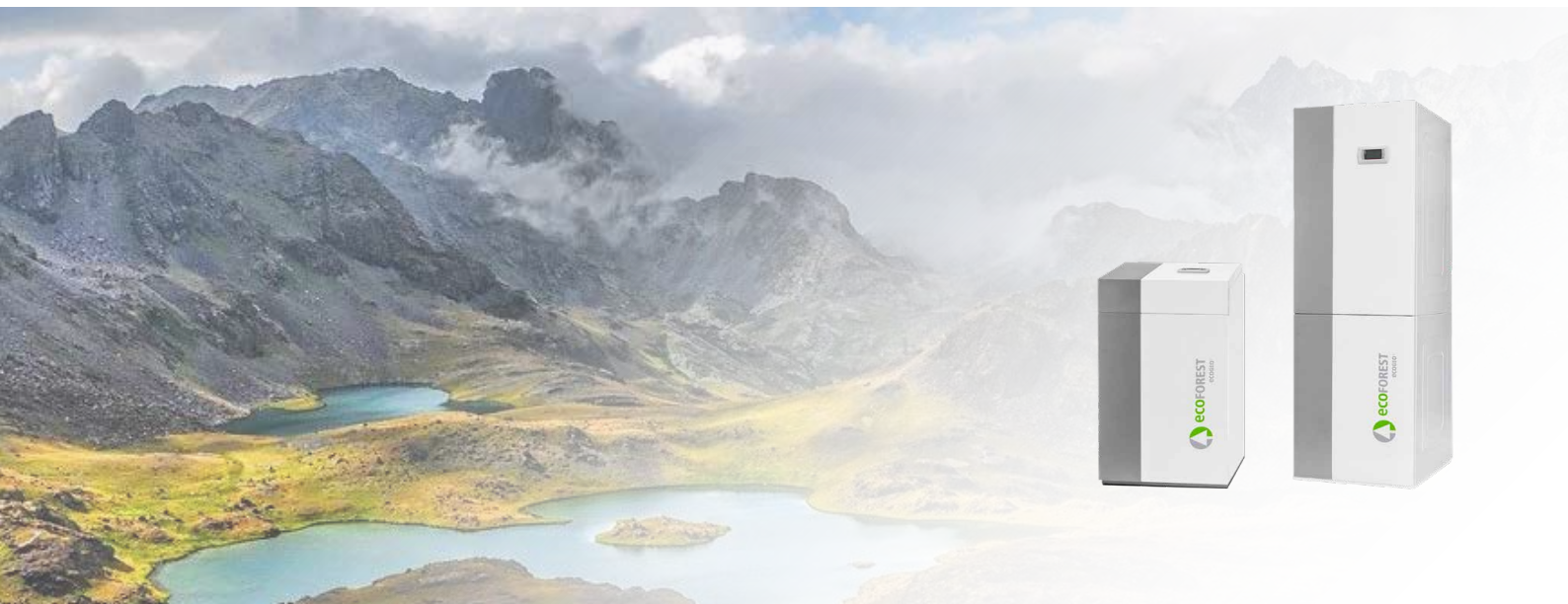
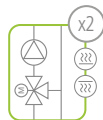
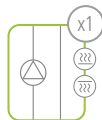
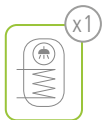

■ Ground source

| Features



Models



ecoGEO+ 1-6 kW PRO



Cascade

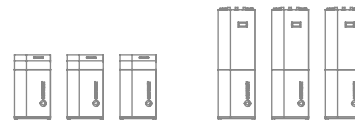

ecoGEO+ PRO, the only one with natural refrigerant

ecoGEO+ PRO heat pump is the only ground source heat pump in the world that uses propane (R290) as refrigerant and can be installed indoors without restrictions. This is possible due to the low refrigerant charge of these units.

The use of propane as a refrigerant makes it possible to achieve exceptional performance and hot water temperatures above 75°C, while using a natural refrigerant.

Ecoforest's philosophy of technological innovation for a sustainable world translates into a unique product ideal for the renovation of existing systems that can guarantee the same thermal performance but with the typical efficiency of ground source.



■ Ground source

ecoGEO⁺ Basic & Compact

Inverter water-to-water heat pumps



- Inverter technology and Scroll compressor
- Power ranges: 1-9 kW / 3-12 kW / 5-22 kW
- Heating, active cooling, passive cooling, DHW and swimming pool production
- Internet control with the ecoSMART easynet kit
- Integrated photovoltaic hybridization
- HTR technology for the production of domestic hot water
- Integrated cascade control up to 3 units
- Single-phase (230V) or three-phase (400V) power supply
- Integrated energy and performance meters
- Control of external auxiliary equipment (gas boilers, heating elements, etc.)
- Hybrid collection systems control
- DHW recirculation control

Services



DHW



Heating



Cooling



Pool

Emissions systems



Radiators



Fancoils



Radiant and cooling floor

Installation management

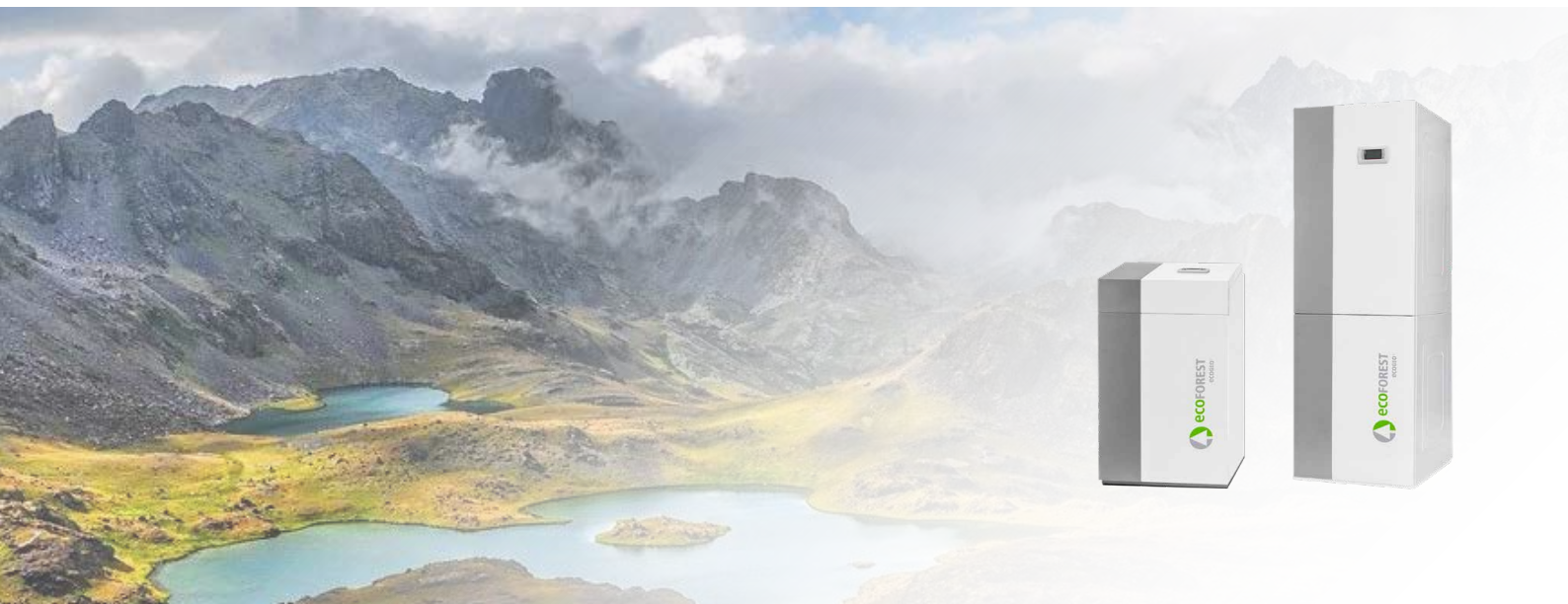
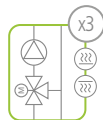
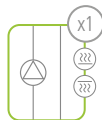
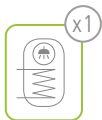

■ Ground source

I Features



Models



Cascade

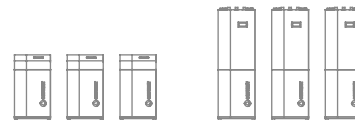

HTR, heat recovery for the best performance

The HTR (High Temperature Recovery) system consists of a heat recovery unit that recovers the thermal energy discharged by the compressor at high temperature when the unit is producing heating or cooling.

Through this heat recovery it is possible to produce domestic hot water up to 70°C. This unique technology also allows the simultaneous production of DHW and heating or DHW and cooling, achieving considerably higher efficiencies than conventional heat

pumps, as the production of hot water is done “for free” by recovering the high temperature at the compressor discharge.

This, together with their Inverter technology and Ecoforest control strategies, makes the ecoGEO+ Basic & Compact units the most efficient ground source heat pumps on the market.

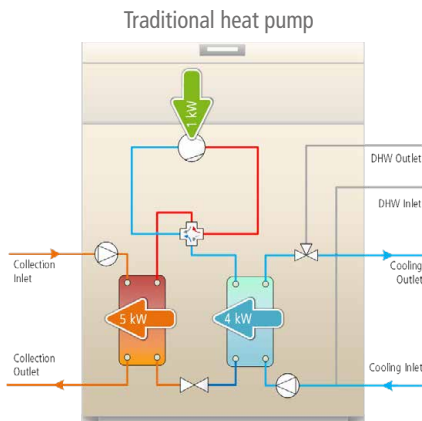

Performance factor (PF) :

$$PF = \frac{\text{USEFUL THERMAL POWER}}{\text{ELECTRICAL POWER CONSUMED}} = \frac{4 \text{ kW}}{1 \text{ kW}} = 4$$

ecoGEO+ heat pump with HTR technology

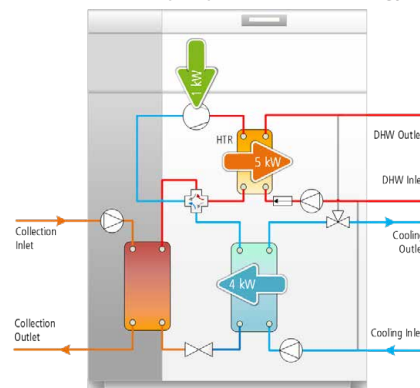

Performance factor (PF) :

$$PF = \frac{\text{USEFUL THERMAL POWER}}{\text{ELECTRICAL POWER CONSUMED}} = \frac{5 \text{ kW} + 4 \text{ kW}}{1 \text{ kW}} = 9$$

■ Ground source

ecoGEO⁺ HP

Inverter water-to-water heat pumps



- Inverter technology and Scroll compressor
- Power ranges: 12-40 kW / 15-70 kW / 25-100 kW
- Heating, active cooling, passive cooling, DHW and swimming pool production
- Internet control with the ecoSMART easynet kit
- Integrated photovoltaic hybridization
- Simultaneous production of heating and cooling
- Hybridization of collection sources with the ecoSMART e-source
- Integrated cascade control up to 6 units
- Three-phase (400V) power supply
- Integrated energy and performance meters
- Control of external auxiliary equipment (gas boilers, heating elements, etc.)
- DHW recirculation control

Services



DHW



Heating



Cooling



Pool

Emissions systems



Radiators



Fancoils



Radiant and cooling floor

Installation management

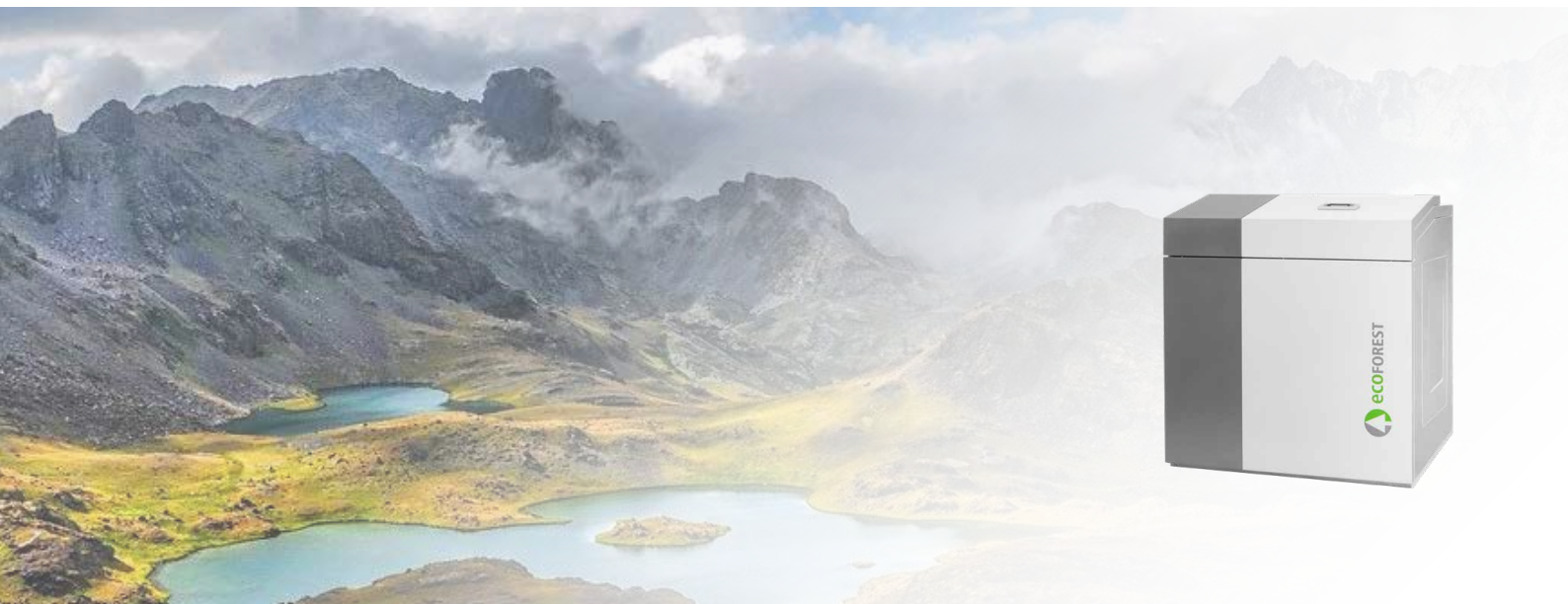
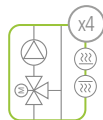
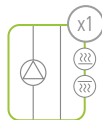
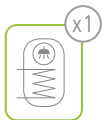

■ Ground source

I Features



Models



Cascade



Simultaneous cooling and heating, the solution for high demands

The thermal needs of industrial, commercial, agricultural, etc. buildings present different energy demands than those corresponding to domestic demands. Depending on the type of use and the services that the building has to provide, these can vary enormously.

It is common that in certain types of buildings, such as hotels, sports halls, spas, centres, agricultural facilities, etc., it is necessary to satisfy heating and cooling needs simultaneously almost all year round. It is in this type of application where a total heat recovery installation (simultaneous production) becomes an ideal solution, and Ecoforest has therefore developed an exclusive technology for the management of this type of installation.

The ecoGEO+ HP heat pumps can manage this type of installation. Thanks to Ecoforest's control strategies and their great modulation capacity, they can modulate their power to adapt it to the most important thermal demand at any given time and use their collection as a source of energy or as a dissipation system in a modulated way to achieve the correct thermal balance in each operating condition.

This makes this solution the simplest, most efficient and economical for this type of installation in which greater efficiency means greater savings and the guarantee of correct operation is critical.



Ecoforest Ground source solutions

ecoGEO+ Basic and Compact

Simplicity and versatility

ecoGEO+ Basic units can be installed with an external hot water tank, so the size can be chosen according to the needs of each installation. The circulation pumps, expansion valves, safety valves and the three-way DHW valve are integrated in the unit, making the installation very simple and compact.

This diagram corresponds to an installation in which the required services are domestic hot water and heating/cooling in a single circuit. As the heat pump includes the circulation pumps inbuilt, it is not necessary to add a buffer tank and no additional hydraulic elements are required.



The most compact all-in-one system



The ecoGEO+ Compact units incorporate a 165 litre stainless steel hot water tank.

This compact design allows the user to meet the needs of DHW, heating, cooling and pool heating. A four-zone heating/cooling installation, which would be very complex with other heat pumps, is very simple and easy to install, as it is possible to avoid installing a buffer tank thanks to the high modulation capacity of the ecoGEO+ heat pumps. In addition, the heat pump also manages the heating of the swimming pool.

The smart cascade

The ecoGEO+ Basic and ecoGEO+ Compact heat pumps can be installed in a cascade of up to 3 units in parallel, reaching a total modulating capacity between 5 kW and 66 kW in a single installation. This does not require any additional control devices, the cascade management is integrated in the control strategies developed by Ecoforest.

These control strategies for cascade installations have a number of advantages, as the system accurately tracks the operating hours of each unit in the cascade to prolong its lifetime, and prioritises its operation at half load to optimise its performance at all times. In addition, the management capacity is multiplied by the number of units in the cascade, resulting in installations capable of meeting any demand.



ecoGEO+ HP

The ideal solution for a classic installation

The ecoGEO+ HP heat pumps enable more efficient and simpler installations for industrial applications. This is also applicable to residential buildings with high thermal needs, as their ability to manage up to 5 heating/cooling zones, the integrated cycle inversion and the possibility of installing a DHW tank according to the needs of each building, make these units capable of adapting to any type of demand.

They also use Inverter technology, with modulation ranges of up to 80%. This makes it possible to considerably reduce the volume of buffer tanks required, or even eliminate them altogether.



Cascade and simultaneous production

The ecoGEO+ HP heat pumps can be installed in cascades of up to 6 units in parallel, this management capacity is possible thanks to the use of the ecoSMART Supervisor, which allows an equal distribution of the operating hours of each unit in the cascade, optimising the life and efficiency of the system by seeking partial load operation of all the heat pumps.

In addition, these heat pumps can manage heat recovery installations, simultaneous production of heating and cooling, with unique performance thanks to the exclusive control strategies developed by Ecoforest.

These two features make the ecoGEO+ HP ideal for installations where heating and cooling needs often occur simultaneously and represent a significant thermal power. In addition, the management capacity of the ecoGEO+ HP heat pumps is multiplied by the number of units in the cascade, making this system more complete in terms of control of the installation and its elements.



Photovoltaic hybridization

Unique hybridization with photovoltaic installation

The ecoGEO+ and ecoAIR+ heat pumps incorporate hybridization management with electricity generation systems from renewable energy sources, which reduces electricity consumption while optimising the operation of the heat pump in a unique way.

This patented technology optimises the available resources in order to achieve self-consumption. In the event of excess electricity production, the heat pump is activated and modulates its power to consume only the excess electricity, achieving a "zero" balance between production and consumption.

This hybridization is compatible with all types of installations and systems.

This is only possible thanks to Ecoforest's advanced control strategies and the performance and modulation capacity of the ecoGEO+ and ecoAIR+ heat pumps.

Compatible models



ecoAIR+



ecoGEO+ Basic



ecoGEO+ Compact



ecoGEO+ HP

How does it work?

The heat pump is connected to an energy meter that provides a reading of the electrical balance between the grid and the house.

In the event that the injection reading corresponds to sufficient electrical power to start the system, the heat pump will activate a "surplus mode" by which it will modify the setpoints of the main Services of the installation to store thermal energy thanks to this free and renewable electrical energy that would be injected into the grid if it were not consumed through this functionality.

This excess power is variable and can change over time, which is why the high modulation capacity of the ecoGEO+ and ecoAIR+ heat pumps is so important. The heat pump will adapt its consumption to consume only the excess energy available at any given time.

Once there is no more excess energy available, the heat pump will return to its normal operating mode, and will have stored as much energy as possible in the form of thermal energy for the different Services. In this way, the services can be supplied at a later date without the heat pump having to be switched on, thus saving a large part of the electricity consumption from the grid.

	DHW	Heating	Cooling	Pool
Normal operating mode	45 °C	35 °C	15 °C	26 °C
Excess operating mode	60 °C	55 °C	7 °C	32 °C



■ Photovoltaic hybridization

The functionalities



- Unique technology: European patent
- Surplus management: storage of surplus renewable electricity as thermal energy
- Tariff control: priority for the operation of the heat pump during off-peak electricity price periods
- Power limitation: modulation of the power consumed by the heat pump in order not to exceed a maximum contracted power
- Hybridization of oecoGEO+ and ecoAIR+ heat pumps with renewable electricity generation systems
- Compatible with production systems: photovoltaic, wind, hydroelectric, etc.
- System to reduce or eliminate electric batteries for energy storage

ecoSMART e-system, a compact solution for homes

The ecoSMART e-system is a unit designed for use in domestic installations to obtain more compact and efficient systems.

This unit includes a photovoltaic inverter, the e-manager and a number of electric batteries to be chosen according to needs, so that all the components of the photovoltaic installation are already included and do not need to be installed.

The e-system is compatible with single-phase domestic installations of less than 5 kW of renewable electricity production and can be connected to up to two lines of photovoltaic panels. It is compatible with all types of photovoltaic panels.

The storage capacity is modular and selectable. The e-system can integrate from 0 to 5 electric batteries of 2.4 kWh each, reaching a maximum storage capacity of 12 kWh, which is more than enough for domestic applications and consumption in individual homes.

These functionalities make it possible to reduce the energy bill by managing the surplus of renewable energy, controlling the electricity tariff and regulating the power consumed by the installation.



Reference installations

Finner camp in Donegal

Location	Donegal (Ireland)
Type of installation	Air source
Type of building	Military barracks
Model	5x ecoAIR+ EVI 4-20 KW
Power	100 KW
Services	DHW, Heating and Cooling



Residential building in Alphen



Location	Alphen (Netherlands)
Type of installation	Air source and common collection
Type of building	Residential building
Model	89x ecoGEO+ C3 1-9 KW HTR EH
Power	801 KW
Services	DHW, Heating and Cooling

Housing development in Madrid

Location	Boadilla del Monte (Spain)
Type of installation	Ground source
Type of building	Single houses
Model	312x ecoGEO+ C3 1-9 KW HTR EH
Power	2.808 KW
Services	DHW, Heating and Cooling



Single house with photovoltaic hybridisation



Location	Leutkirch (Alemania)
Type of installation	Ground source
Type of building	Single house
Model	ecoGEO+ C4 T 3-12 KW HTR EH
Power	12 KW
Services	DHW, Heating and Cooling

Reference installations

Bath Abbey Cathedral

Location	Bath (United Kingdom)
Type of installation	Ground source, groundwater
Type of building	Cathedral
Model	2x ecoGEO+ HP1 25-100 KW
Power	200 KW
Services	Heating



Hotel Casino in Cyprus



Location	Girne (Cyprus)
Type of installation	Hybrid (Seawater and air source)
Type of building	Hotel and casino
Model	12x ecoGEO+ HP1 25-100 KW
Power	1.200 KW
Services	DHW, Heating and Cooling

Ecoforest Headquarters

Location	Nigrán (Spain)
Type of installation	Groundwater
Type of building	Factory and offices
Model	2x ecoGEO+ HP3 25-100 KW
Power	200 KW
Services	DHW, Heating and Cooling





ECOFORREST GEOTERMIA, S.L.

Parque Empresarial Porto do Molle · Rúa das Pontes 25
36350 Nigrán - Pontevedra (Spain)

+34 986 262 184

www.ecoforest.com

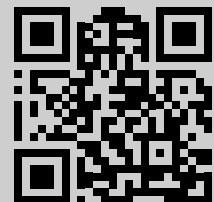

Ecoforest shall not be held responsible for any error contained in this these catalogue and reserves the right to make any modifications it deems necessary for both technical and commercial reasons at any time and without prior notification. The availability of any equipment described in this document shall always be confirmed by Ecoforest. The inclusion of the equipment in this catalogue does not imply an immediate availability.